

safe·n·sound

HARNESSED SEAT

Suitable from 6 months to 8 years (approx)

Instructions for Installation & Use

Series No. BS090GA-020133

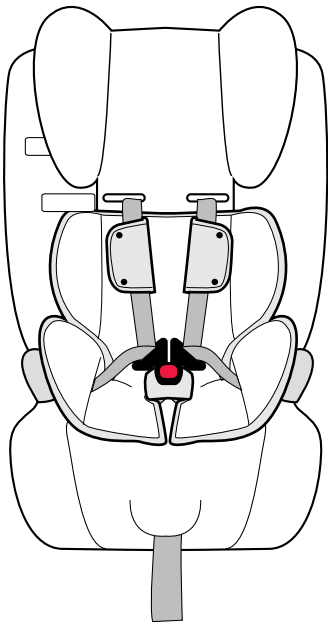

IMPORTANT:

KEEP THIS BOOKLET IN THE PLACE PROVIDED ON THE CHILD RESTRAINT

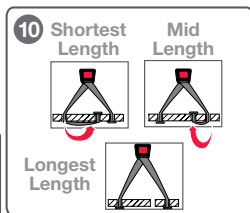
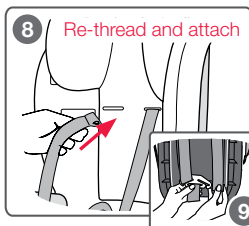
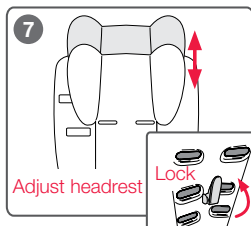
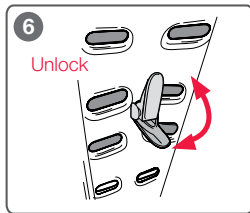
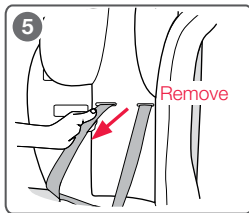
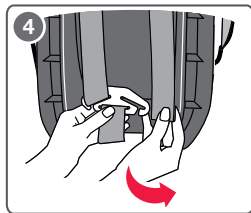
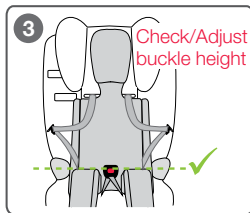
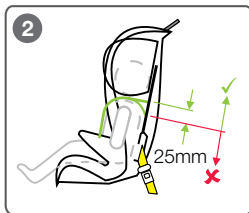
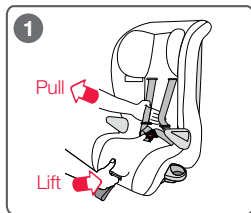

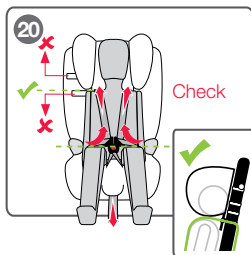
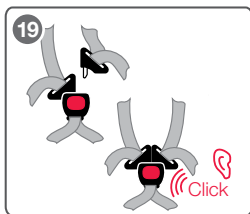
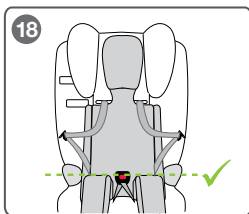
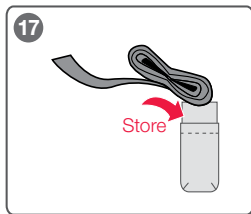
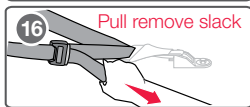
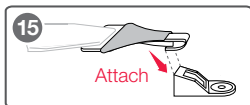
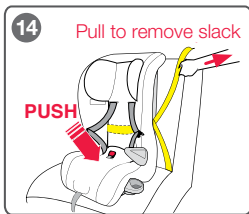
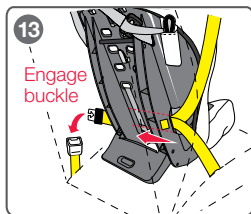
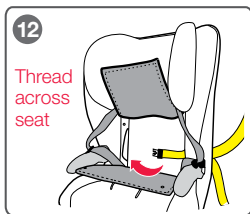
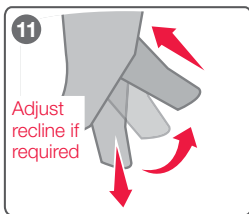

To be used only in a forward-facing position by a child whose shoulders are above the lower shoulder height marker (approximately 6 months of age) until the child's shoulders reach the upper shoulder height marker (approximately 8 years of age). Continue to use this child restraint until the child reaches this limit. Do not use this child restraint until child's shoulders are above the lower shoulder height marker.

Infants are at risk of serious injury if they face forward too early.

Children are at risk of serious injury if they move to booster seats too early.

Just using a seatbelt is not recommended for children that have outgrown this restraint.

Children are safest in a booster seat until their shoulders reach the upper shoulder height marker of the booster seat.

للاستخدام في الوضعية المواجهة للأمام من قبل طفل كتفيه أعلى من الإشارة السفلية لارتفاع الكتف (حوالي 6 أشهر من العمر) وحتى يصل كتفا الطفل إلى الإشارة العلوية لارتفاع الكتف (حوالي 8 سنوات من العمر).

استمر في استخدام حاجز الأطفال هذا لحين وصول الطفل إلى هذا الحد.

لا تستخدم حاجز الأطفال هذا إلا عندما يكون كتفي الطفل قد تجاوزا علامة ارتفاع الأكتاف السفلية.

يكون الرضع في مخاطرة للتعرض إلى الإصابات الخطيرة إذا تم توجيههم إلى الأمام بصورة مبكرة أكثر من اللازم.

يكون الأطفال في مخاطرة للتعرض إلى الإصابات الخطيرة إذا ما انتقلوا إلى مقاعد الأمان المرتفعة بصورة مبكرة أكثر من اللازم.

لا نوصي بمجرد استخدام حزام الأمان للأطفال الذين كبر حجمهم عن هذا الحاجز. يكون الأطفال أكثر أماناً في مقعد أمان مرتفع حتى تصل أكتافهم إلى علامة ارتفاع الأكتاف العلوية لمقعد الأمان المرتفع.

Na χρησιμοποιείται στραμμένο προς τα εμπρός μόνο από ένα παιδί του οποίου οι ώμοι είναι πάνω από τον χαμηλότερο δείκτη ύψους ώμου (περίπου 6 μηνών) μέχρι οι ώμοι του παιδιού να φτάσουν στον ανώτερο δείκτη ύψους ώμου (περίπου 8 ετών).

Συνεχίστε να χρησιμοποιείτε αυτή την παιδική διάταξη συγκράτησης μέχρι το παιδί να φτάσει σε αυτό το όριο.

Μην χρησιμοποιείτε αυτό το σύστημα συγκράτησης παιδιού μέχρι οι ώμοι του παιδιού να είναι πάνω από τον χαμηλότερο δείκτη ύψους ώμων.

Τα βρέφη κινδυνεύουν με σοβαρό τραυματισμό αν το κάθισμα κοιτάζει προς τα εμπρός πολύ νωρίς.

Τα παιδιά διατρέχουν κίνδυνο σοβαρού τραυματισμού, εάν μετακινηθούν σε βοηθητικά καθίσματα πολύ νωρίς.

Η χρήση μόνο μιας ζώνης ασφαλείας δεν συνιστάται για παιδιά που έχουν ξεπεράσει αυτό το σύστημα συγκράτησης. Τα παιδιά είναι ασφαλέστερα σε ένα βοηθητικό κάθισμα μέχρι οι ώμοι τους να φθάσουν το ανώτερο δείκτη ύψους ώμου στο βοηθητικό κάθισμα.

Chỉ được sử dụng ở vị trí hướng mặt về phía trước cho em nào có vai ở trên vạch ghi độ cao của vai ở dưới cùng (khoảng 6 tháng tuổi) cho đến khi vai của em cao tới vạch ghi độ cao của vai ở trên cùng (khoảng 8 tuổi).

Hãy tiếp tục sử dụng ghế em bé này cho đến khi em cao tới giới hạn này.

Không sử dụng ghế em bé này cho đến khi vai của em ở trên vạch ghi độ cao của vai ở dưới cùng.

Bé sơ sinh có nguy cơ bị chấn thương nghiêm trọng nếu hướng mặt về phía trước quá sớm.

Các em có nguy cơ bị chấn thương nghiêm trọng khi đổi sang ghế trẻ em (booster) quá sớm.

Chỉ sử dụng dây nịt an toàn không được đề nghị cho các em lớn hơn ghế em bé này. Trẻ em được an toàn nhất trong ghế trẻ em cho đến khi vai của em cao tới vạch ghi độ cao của vai ở trên cùng của ghế trẻ em (booster).

僅可前向安裝使用，適用於肩膀超過靠下的肩高度標記的孩子（大約6個月大），直至其肩膀達到靠上的肩高標記（大約8歲大）。

繼續使用此座椅直至孩子達到此安全座椅的上限。

孩子肩膀超過靠下的肩高標記之前，切勿使用此座椅。

孩子若過早乘坐前向式汽車座椅，可能會對其造成嚴重的傷害。

急於讓孩子過早地乘坐墊高椅，可能會對其造成嚴重的傷害。

孩子因長大超出墊高椅的上限時，不推薦僅僅使用安全帶。孩子在其肩膀超過靠上的肩高標記之前，使用墊高椅是最安全的做法。

Da utilizzare solo nel senso di marcia da un bambino le cui spalle sono sopra l'indicatore di altezza inferiore della spalla (circa 6 mesi di età) fino a quando le spalle del bambino raggiungono il marcatore di altezza della spalla superiore (circa 4 anni di età).

Continuare a utilizzare questo sistema di ritenuta del bambino fino a quando raggiunge questo limite.

Non utilizzare il seggiolino fino a quando le spalle del bambino sono al di sopra del marcatore di altezza inferiore.

I neonati sono a rischio di lesioni gravi se messi in posizione frontale troppo presto.

I bambini sono a rischio di lesioni gravi se si muovono dal seggiolino troppo presto.

Usare soltanto la cintura di sicurezza non è raccomandato per i bambini che hanno superato questo limite.

I bambini sono più sicuri in un seggiolino fino a quando le loro spalle raggiungono il marcatore di altezza superiore del seggiolino.

肩膀超过靠下肩高标记的婴儿（大约6个月的宝宝）只采用前向式安装，直到儿童肩膀达到靠上的肩高标记（大约8岁的儿童）。

在儿童达到该座椅上限以前必须不断使用这一安全座椅。

在儿童肩膀超过靠下的肩高标记前不得使用该儿童安全座椅。

婴儿若过早乘坐前向式座椅则可能受到严重的伤害。

儿童过早使用垫高椅则可能受到严重的伤害。

不建议个子比该座椅大儿童仅仅使用安全带。儿童肩膀达到该垫高椅靠上的肩高标记以前最安全的办法是使用垫高椅。

Magagamit lamang sa isang nakaharap pasulong na posisyon ng isang bata na ang mga balikat ay lampas sa ibabang marka ng taas ng balikat (humigit-kumulang 6 na buwang edad) hanggang sa maabot ng mga balikat ng bata ang itaas na marka ng taas ng balikat (humigit-kumulang 8 na taong gulang).

Ipagpatuloy ang paggamit ng pampigil ng bata na ito hanggang sa maabot ng bata ang limitasyong ito.

Huwag gamitin ang pampigil sa bata na ito hanggang sa ang mga balikat ng bata ay lumampas sa ibabang marka ng taas ng balikat.

Ang mga sanggol ay nasa seryosong peligro ng pagkapinsala kung sila ay haharap ng masyadong maaga.

Ang mga bata ay nasa seryosong peligro ng pagkapinsala kung sila ay masyadong maagang lilipat sa mga upuang booster.

Ang paggamit lamang ng seatbelt ay hindi inirerekomenda para sa mga bata na nakalakhan na ang pampigil na ito. Ang mga bata ay pinakaligtas sa isang upuang booster hanggang sa maabot ng kanilang mga balikat ang itaas na marka ng taas ng balikat ng upuang booster.

केवल उस शिशु द्वारा मात्र सामने की दशा की स्थिति में प्रयोग किया जाना चाहिए जिसके कन्धे कन्धे के नचिले भाग से ऊपर आ गए हों (लगभग 6 महीने की आयु पर) और तब तक जब तक कि शिशु के कन्धे कन्धे के ऊपरी भाग के चनिह तक न पहुँच जाएँ (लगभग 8 वर्ष की आयु पर)।

शिशु के इस सीमा तक पहुँचने तक इस शिशु प्रतबिन्ध का प्रयोग जारी रखें।

शिशु प्रतबिन्ध का प्रयोग तब तक न करें जबतक कि शिशु का कन्धा कन्धे के नचिले भाग के चनिह को पार न करे।

शिशुओं को समय से पहले सामने की ओर बैठाए जाने पर उन्हें गम्भीर चोट का खतरा होता है।

बूस्टर सीट को समय से पहले प्रयोग किए जाने पर शिशुओं को गम्भीर चोट का खतरा होता है।

जनि शिशुओं की आयु इस सीट के लिए उचित आयु से अधिक हो गई हो उनके लिए मात्र सीटबैल्ट के प्रयोग का सुझाव नहीं दिया जाता है। शिशु बूस्टर सीट में तब तक सबसे अधिक सुरक्षित होते हैं जब तक कि उनके कन्धे बूस्टर सीट के कन्धों के उपरी चनिह तक न पहुँचे।

Sólo debe utilizarse orientado hacia adelante para un niño cuyos hombros sobrepasen el marcador de altura inferior (aproximadamente a los 6 meses de edad) hasta que los hombros del niño alcancen el marcador de altura superior (aproximadamente a los 8 años de edad).

Utilice este sistema de seguridad infantil hasta que el niño alcance ese límite.

No utilice este sistema de seguridad hasta que los hombros del niño no sobrepasen el marcador de altura inferior.

El niño corre el riesgo de sufrir lesiones graves si se utiliza la silla orientada hacia adelante antes de tiempo.

El niño corre el riesgo de sufrir lesiones graves si se lo traslada antes de tiempo a un asiento elevador.

No se recomienda utilizar sólo un cinturón de seguridad para el niño que ya no quepa en este asiento. El niño estará más seguro en un asiento elevador hasta que sus hombros alcancen el marcador de altura superior del asiento elevador.

Carefully read all the instructions for installation in this book. If in doubt about the method of installation, consult Safe-n-Sound® or agent or a child restraint fitter or, in New Zealand, to consult the agent for the vehicle.

This car seat is suitable for toddlers and older children as a harnessed child restraint from 6 months to 8 years of age (approximately).

TO BE USED WITH A LAP-SASH OR LAP ONLY SEATBELT IN THE BACK OF MOST CARS WITH FORWARD FACING SEATS.

The child should not sit in this forward facing child restraint until their neck muscles are able to support their head. Safe-n-Sound® recommends that you keep your child in a rearward facing restraint for as long as possible (up to approximately 12 months or more).

Regional Road Rules may prohibit the use of a restraint in the front seat of a vehicle until the child is 4 years of age. Check your Regional Rules for exemptions.

No child restraint can guarantee absolute protection from injury in every crash. However, to ensure that your child gets all the protection designed into the restraint. PLEASE READ AND FOLLOW THESE INSTRUCTIONS EXACTLY and use only Safe-n-Sound® recommended parts and accessories.

THIS RESTRAINT MUST BE ATTACHED TO A CHILD RESTRAINT UPPER ANCHORAGE POINT IN THE CAR. REFER TO CAR OWNER'S HANDBOOK FOR LOCATION OF UPPER ANCHORAGE POINTS. REFER TO A CHILD RESTRAINT FITTING STATION IF NO UPPER ANCHORAGE POINTS ARE IN THE MOTOR CAR. Refer to pages 37.

Follow these instructions so that the protection to the occupant is not reduced. The seat belt, tether strap, headrest and harness must be adjusted correctly and the restraint reclined as instructed. For particular advice refer to the index on the next page.

This child restraint is not suitable for use on an aircraft.

Always store the instruction book in the pocket provided on the side of the cover.

- 10 WARNINGS
- 12 SPECIAL FEATURES
- 14 SHOULDER HEIGHT MARKERS & A GROWING CHILD
- 16 SHOULDER HEIGHT LABELS & THE NEXT STEP
- 17 SUITABLE FOR USE
- 18 HOW TO SETUP
- 24 HOW TO INSTALL
- 28 HOW TO USE
- 30 HOW TO REMOVE
- 31 CARE AND MAINTENANCE
- 34 ACCESSORIES AND FEATURES
- 37 INSTALLATION OF CARS UPPER ANCHOR FITTING
- 41 IN CASE OF ACCIDENT

**WARNINGS**

- Fit the restraint firmly to the car seat.
- Fit the harness firmly to the child.
- A loose restraint or harness is dangerous.
- Supervision of children is needed because they may be able to undo buckles and adjusters.
- Use the restraint exactly as shown in the instructions.
- **DO NOT LEAVE CHILDREN UNATTENDED IN THE CAR.**
- Do not alter or modify this restraint.
- Repairs must only be done by the manufacturers or agent.
- Do not allow the restraint to come into contact with polishes, oils, bleach and other chemicals.
- Destroy the restraint if it has been in a severe crash, even if no damage is visible. See page 41.
- **DO NOT USE THIS RESTRAINT WITHOUT THE COVER.**
- Always secure the loose end of the top tether strap. Do not use the child restraint where this strap may fall into the seat back or off the side of the seat.
- **ALWAYS ATTACH HOOK AND REMOVE SLACK.**
- **DO NOT ATTACH THIS CHILD RESTRAINT TO ANY ISOFIX LOW ANCHORAGE.** ISOFIX low anchorages in cars are designed to withstand only those loads imposed by children aged up to approximately 4 years of age in a correctly fitted and approved ISOFIX compatible child restraint. This child restraint is not approved for use with the car's ISOFIX low anchorages.

**IMPORTANT:**

- Regularly check the restraint components, straps and other fitments for correct function and condition. Seek prompt repair.
- IF AN AIRBAG IS FITTED IN THE SEATING POSITION WHERE THE CHILD RESTRAINT IS TO BE FITTED, FOLLOW THE VEHICLE MANUFACTURERS WARNINGS AND INSTRUCTIONS.
- Protect all webbing from abrasion and cutting by sharp corners and edges.
- The restraint should not be purchased or sold as a second hand item. It is recommended not to use child restraints older than 10 years as the protection in an accident may be reduced.
- This restraint must be used in conjunction with a lap or lap-sash seatbelt.
- The restraint should not be purchased or sold as a second hand item. It is recommended not to use child restraints older than 10 years as the protection in an accident may be reduced.
- This restraint must be used in conjunction with a lap or lap-sash seatbelt.
- THIS RESTRAINT IS NOT SUITABLE FOR USE WHERE THE TOP TETHER STRAP MAY FALL INTO A SPLIT IN THE SEAT BACK OR OFF THE SIDE OF THE SEAT.
- Seatbelt extenders are not recommended to be used if the seatbelt is not long enough to secure the child restraint. If seatbelts are too short then seek advice from a child restraint fitter and consider their recommendations before using a seatbelt extender. If you use a seatbelt extender then ensure that the seatbelt buckle does not contact the child.

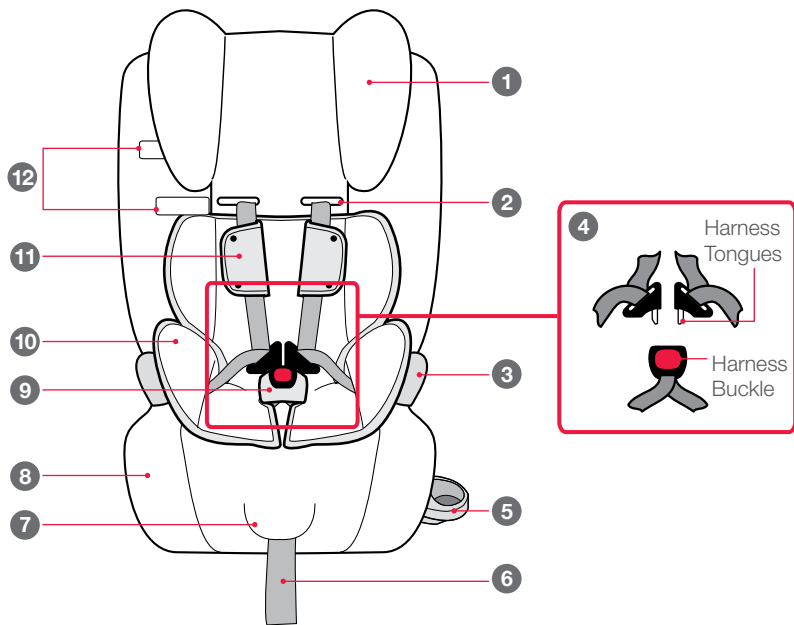

1. Adjustable Headrest

2. Harness Slots

3. Armrests

4. Harness Tongues and Buckle
(Red button)

5. Cup Holder (if fitted)

6. Harness Adjustment Strap

7. Harness Adjustment Lever
(under flap)

8. Padded cover for comfort

9. Crotch Pad (If fitted)

10. Padded Insert (If fitted)

11. Shoulder Pads (If fitted)

12. Shoulder Height Markers

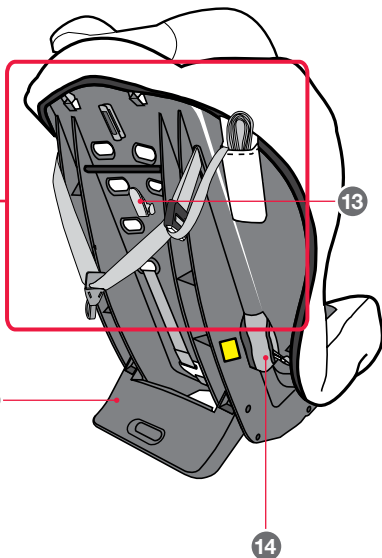
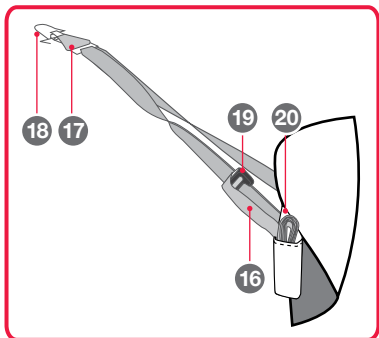

- 13. Headrest Lever
- 14. Forward Facing Belt Path
- 15. Adjustable Recline Foot
- 16. Adjustable Top Tether Strap
- 17. Attachment Clip
- 18. Car's Upper Anchorage fitting
- 19. Top Tether Strap Adjuster
- 20. Top Tether Storage Pocket
(attached to cover)

NOTE: Not all features are supplied on some models."if fitted" is used to indicate some of the features that may not be on the child restraint supplied.

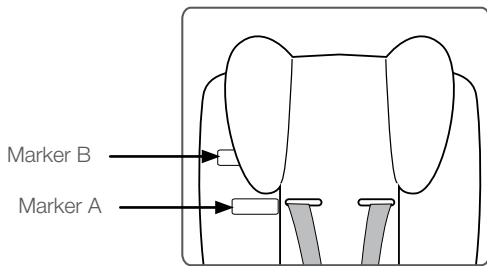

Shoulder height marker **B** is visible when the headrest is fully raised.

YOUNG CHILD

Commence use when shoulders must not be below the lowest shoulder height marker.

From approximately 6 months of age.

However, Safe-n-Sound® recommends that you keep your child in a rearward facing restraint for as long as possible (up to approx 12 months).

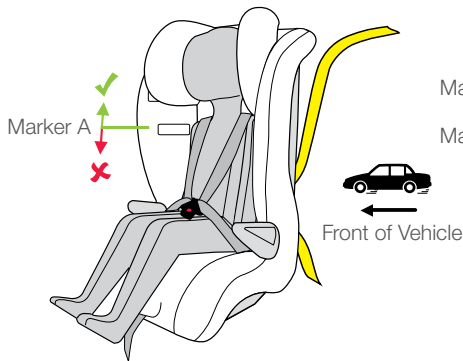

OLDER CHILD

Discontinue use when shoulders are in-line with highest marker.

To approximately 8 years of age.

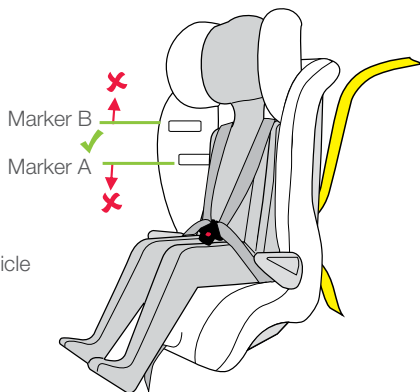

Change to the next type of booster seat or vehicle seatbelt when shoulders reach the upper shoulder height marker when the headrest is in the highest position.

If a child no longer physically fits in the seat then move to the next form of child restraint.

 **IMPORTANT: Follow this advice.**

MARKER A SMALLER TODDLER - LOWER SHOULDER HEIGHT MARKER

The child's shoulders must be in-line or above this marker. If the child's shoulders are below then the child should remain in their previous child restraint. Approximately 6 months.

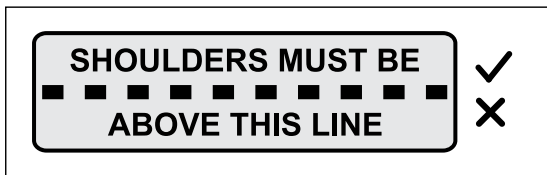

MARKER B LARGER CHILD - UPPER SHOULDER HEIGHT MARKER

When the child's shoulders reach this upper marker, or the child no longer fits in the child restraint, approximately 8 years of age, then the child must be moved to the next form of child restraint, see next page.

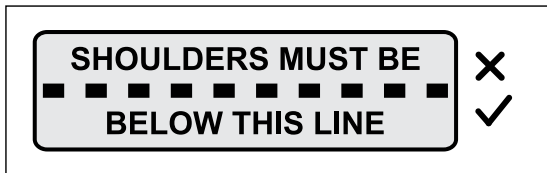

Next type of restraint that can be used in the car for your child.

When your child has outgrown this seat, you can use:

- Use a booster seat suitable for children up to 8-10 years of age with the car's seatbelt.*

OR

- A child may use the vehicle seat and seatbelt without a booster seat if the child's legs hang over the seat edge.

Otherwise if the child's legs do not hang over the edge of the vehicle seat then they need to use a booster seat so that the seatbelt fits correctly and so the child does not slump. A lap seatbelt on the child's abdomen is dangerous.

NOTE: This child restraint includes a booster seat configuration for children 4 years to approximately 6 to 8 years.

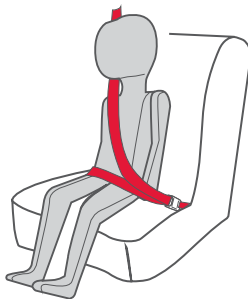
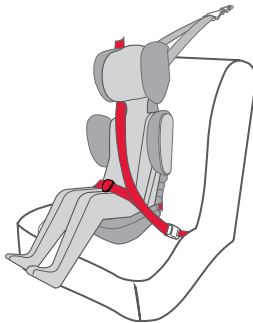

TO BE USED WITH A LAP SASH OR LAP ONLY SEAT BELT IN THE BACK OF MOST CARS WITH FORWARD-FACING SEATS.

To be used only in a forward-facing position by a child whose shoulders are above the lower shoulder height marker (approximately 6 months of age) until the child's shoulders reach the upper shoulder height marker (approximately 8 years of age).

This child restraint uses a top tether strap and needs to be placed in a car seating position with a child restraint anchor fitting or anchorage point. If there is no anchor fitting see pages 36 to 38.

Infants are at risk of serious injury if they face forward too early.

The child should not sit in this forward facing child restraint until their neck muscles are able to support their head. Stay in a rear facing child restraint.

Regional Road Rules may prohibit the use of a restraint in the front seat of a vehicle until the child is 4 years of age. Check your Regional Rules for exemptions.



WARNINGS

- Fit the restraint firmly to the car seat and then fit the harness firmly to the child.
- A loose restraint or harness is dangerous.
- Do not use this restraint if the child's shoulders are below the lowest shoulder height marker.
- Do not use in a front seat, unless it has a child restraint anchorage point.
- Do not use the restraint without the Top Tether Strap correctly attached.
- Do not use on any vehicle seat which faces sideways or rearwards.
- WHERE AN AIRBAG IS FITTED IN THE SEATING POSITION WHERE THE CHILD RESTRAINT IS TO BE FITTED, FOLLOW THE VEHICLE MANUFACTURERS WARNINGS AND INSTRUCTIONS.



IMPORTANT:

Use lap or lap-sash seat belt and upper anchorage strap to attach the child restraint to the vehicle seat when using the in-built harness.

SETTING UP THE HARNESS

- Put the restraint on a flat ground and supported from behind so that it will not tip over.
- Sit the child comfortably in position.
- Check the height of the buckle and adjust if necessary as detailed on page 23.
- Determine the desired headrest position, just above the child's shoulders.
- Remove the child and adjust the shoulder straps if necessary as detailed on page 19 and 22.
- Repeat steps A-D to confirm the correct set-up of the built-in harness.

ADJUSTING THE BUCKLE POSITION

The buckle needs to be positioned as shown. If the buckle is too low it will be uncomfortable and needs to be lengthened. See next page for adjusting to a better position.

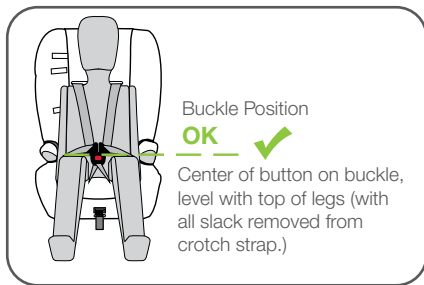

IMPORTANT:

You must adjust the crotch strap to the correct length for your child before installing the restraint as it cannot be adjusted in the car. The crotch strap should only be extended if the harness tongues are located low against your child's legs, thus creating discomfort.

Always return the crotch strap to its shorter length when using the seat with a smaller child. The buckle should always be positioned low down on your child's abdomen.

ADJUSTING SHOULDER HARNESS STRAPS

Correct fitment of the harness is very important to protect the child. The harness must fit firmly around the upper torso of the child and be positioned so as to leave the child's arms and legs free.

1. Lower shoulder strap slots
2. Mid shoulder strap slots
3. Upper shoulder strap slots
4. Top slots in seat back
5. Headrest clamp
6. Lower Height Marker
7. Upper Height Marker
8. Harness Slots in Headrest
9. Shoulder harness straps
10. Harness tongues & buckle
11. Lap strap slots
12. Crotch strap slots
13. Harness adjustment strap

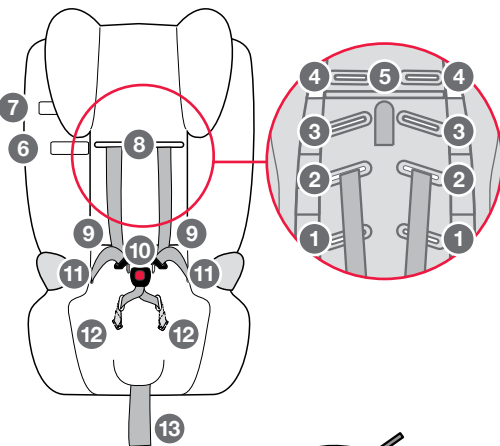

The shoulder straps must be in the slots which are nearest to the child's shoulders, but not more than 25mm below the child's shoulders.

Always adjust the height of the shoulder straps and crotch straps as the child grows.

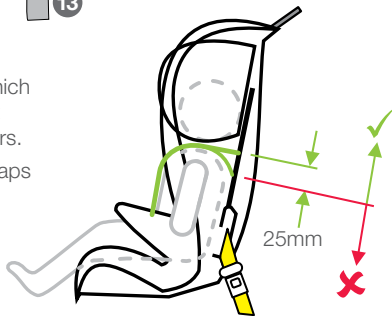

ADJUSTING HARNESS STRAP HEIGHT & HEADREST:

STEPS IN CHANGING SHOULDER STRAP SLOTS

- A. To adjust harness strap height and/or adjust headrest, lengthen the harness by lifting the lever and pull the harness to lengthen.

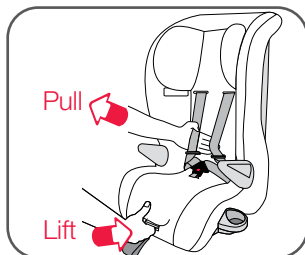

- B. At the rear of the restraint, remove both harness shoulder straps from metal Strap Connector by slipping strap through open slot.

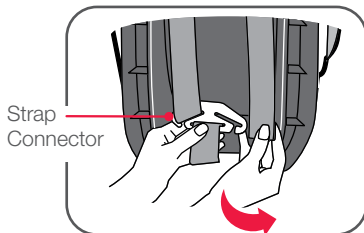

- C. Pull the shoulder straps through slots at the front of the restraint.

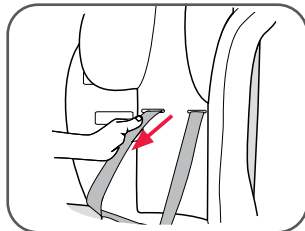

- D. Release the headrest at the back of the restraint by rotating the lever down to loosen headrest clamp (1). Slide the headrest up or down to suit the height of your child. Ensure that the headrest slots align with the corresponding slots of the seat shell. Rotate the lever upward to clamp the headrest (2). DO NOT clamp the headrest in any position, with the slots not aligned correctly. Check alignment of slots as shown in Fig 1.

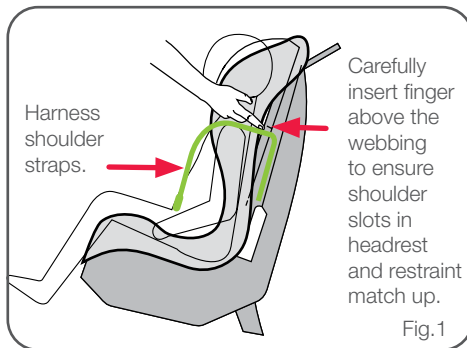
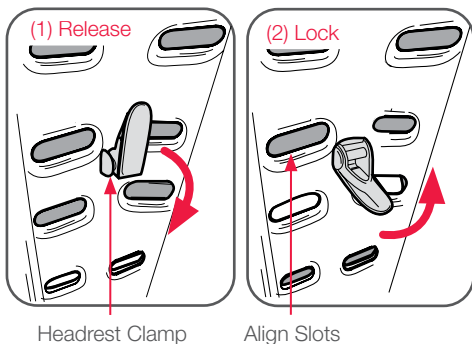
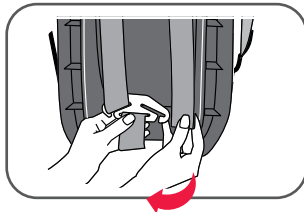
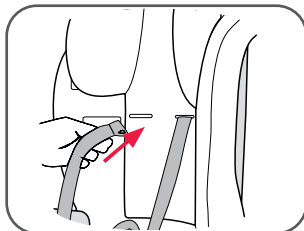

Fig.1

- E. Thread the shoulder straps through the slots. If it is the top slot ensure you have placed the harness over the bar, see below image 4.

Engage the straps to the metal strap connector.



IMPORTANT:

Never adjust the height of the headrest without changing the harness strap slots.

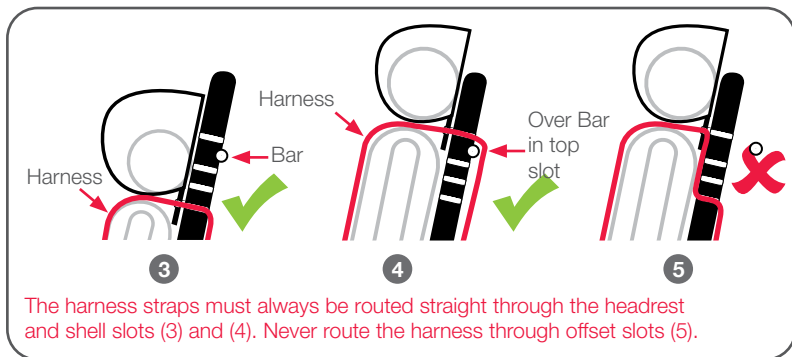

The harness straps must always be routed straight through the headrest and shell slots (3) and (4). Never route the harness through offset slots (5).

ADJUSTING THE CROTCH BUCKLE HEIGHT

The crotch buckle height can be adjusted by threading the 3 bar slide into other slot configurations.

- Lift trim cover to reveal crotch strap slots and the 3 bar slide.
- Turn the crotch 3-bar slide and push through each slot as shown right until the Crotch strap assembly through the slot. Turn the seat over to access the 3 bar slide underneath the seat.
- Having released the 3 bar slide this forms the longest length. If a mid-length is required, take the 3 bar slide from an outer slot and feed through the centre slot by turing the 3 bar slide on its side to form a short loop. See 2 below.
- Repeat steps A,B and C and leave the 3 bar slides underneath the seat to achive the highest crotch strap length. See 3 below.
- Refit the cover.
- Pull the crotch buckle upwards to remove slack.
- Check the buckle height on the child's thighs.

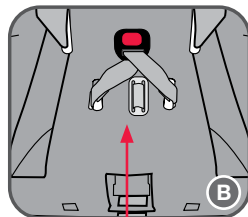

Centre Slot

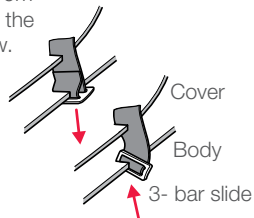

1. Shortest Length for smaller size child

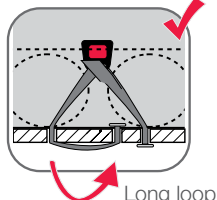

Long loop

2. Mid Length for Mid size Child

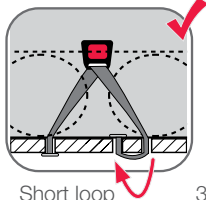

Short loop

3. Longest Length for larger child

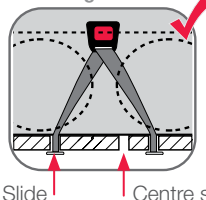

3 Bar Slide

Centre slot

Centre of buckle above the thighs



IMPORTANT:

When replacing cover, ensure none of the harness straps are twisted and that all straps are secure by pulling each harness strap.

INSTALLING INTO VEHICLE

(FORWARD-FACING) (UPRIGHT OR RECLINED)

- A. Determine whether an upright or reclined installation is required.
- B. To move the Recline Foot from upright to reclined mode or vice versa. Pull the Foot outwards to unlock it, then rotate the foot.

Push inwards to lock in place.
See diagrams below.

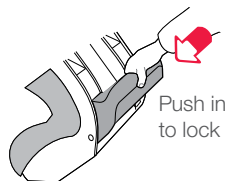
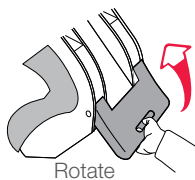
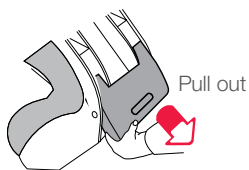
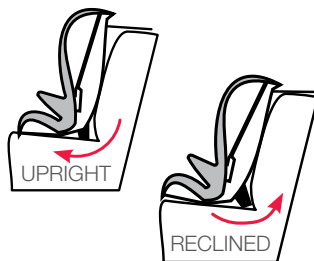

- C. Position restraint centrally to the chosen car seat position. The restraint must be in a forward facing direction. Some vehicle seat fabrics (particularly velours) may be damaged by a child restraint used continuously. We recommend the use of a thick towel or other protection under and behind the seat to keep the vehicle seat in good condition.

Pull the centre panel flap down and gently lift headrest trim end.

Fully lengthen seatbelt and feed the seatbelt through the closest seatbelt path slot and pass across the seating surface through the opposite slot. Follow the yellow belt path label -

FORWARD-FACING BELT PATH

and engage the seatbelt into the buckle.

Put the top tether strap over the back of the seat to avoid it becoming trapped during seat fitment.

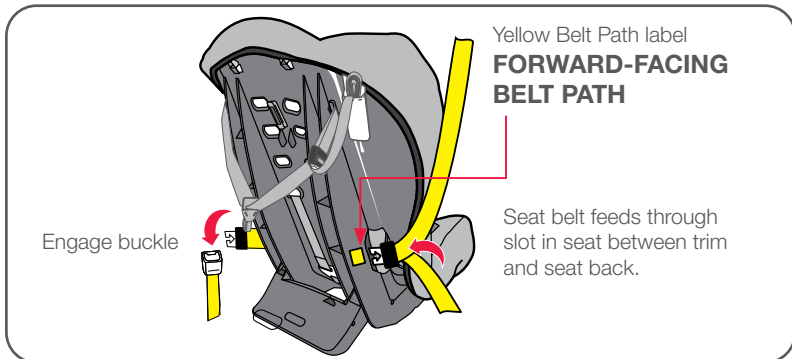
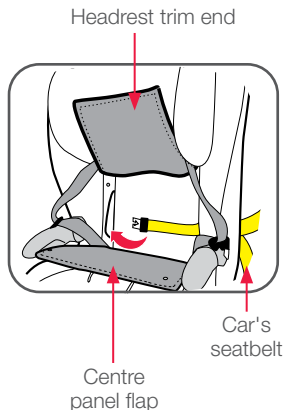

- D. Lengthen the top tether strap and connect the attachment clip to the car's upper anchorage point making sure to remove as many twists as possible.

Lengthen the top tether strap by fully pressing the adjuster button (A) while pulling top tether strap (B) to slacken as shown left.

Refer to your vehicle owner's manual for the location of the upper anchorage point in the car. If the vehicle is not fitted with a child restraint upper anchorage point then refer to page 37 to 40 for the installation of the upper anchorage point provided with this child restraint.

- E. Push down on the restraint to compress it into the vehicle seat. Whilst compressed in the seat, pull on the lap portion to remove all slack from the belt. Pull the sash belt and allow excess belt to feed back into the retractor. Ensure all slack is removed from the lap and sash belt.
- F. The restraint should now be held firmly against the vehicle seatback. The top tether should be left slack until the sash belt is fitted and all slack removed.

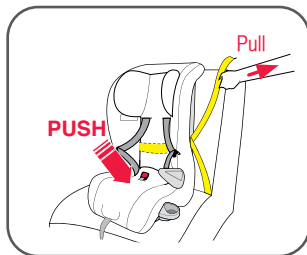
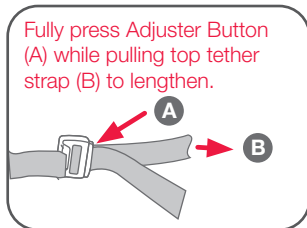
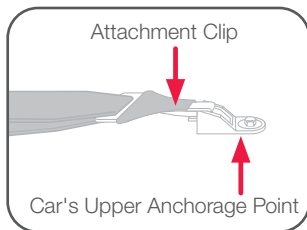

CAUTION:

CHILDREN CAN BE INJURED OR RESTRAINTS AND TOP TETHER STRAP DAMAGED BY UNSECURED CARGO IN A COLLISION. SECURE OR REMOVE HAZARDOUS CARGO BEFORE USING THIS CHILD RESTRAINT.

- G. Pull the top tether adjustment strap (C) to remove all slack but do not tighten.

Always secure the loose end of the top tether strap to prevent it hanging out of the car or being accessible to the child. Fold up excess strap and use pocket to store excess strap behind seat.

EXPLANATION NOTE: This method of installation ensures good seatbelt tension, even with the child in the seat. We recommend that as your child grows, you should periodically check the seatbelt and top tether tension to ensure that the car seatbelt has not slackened and the top tether strap is not too tight.

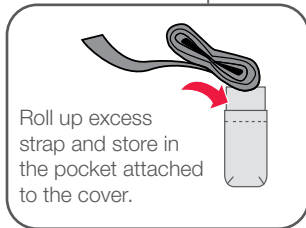
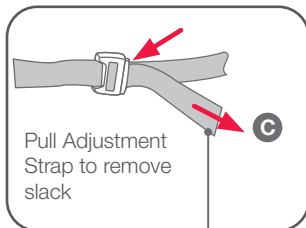

IMPORTANT:

Always ensure that the car seatbelt is firmly restraining the child restraint on the vehicle seat and ensure the slack is removed from the tether strap.

Always secure the loose end of the top tether strap to prevent it hanging out of the car or being accessible by the child. Do not use the child restraint where this strap may fall into a split in the seatback or off the side of the seat.

Make sure cup holders (if fitted) do not interfere with closure of the car door.

ALWAYS attach top tether hook and remove slack.

PLACING CHILD IN THE RESTRAINT

- A. To lengthen harness lift harness adjustment lever while pulling on both shoulder straps evenly until the harness will accommodate the child.

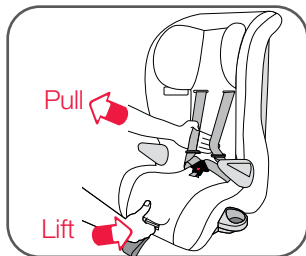

- B. Place the child in the restraint and feed each arm through shoulder straps. Pull the harness buckle up between child's legs.

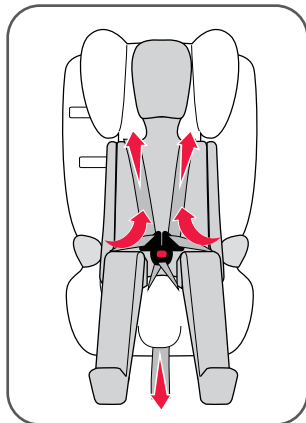

- C. Fit either harness tongue into the buckle followed by the other tongue. A click is heard when the second tongue is fully engaged. Should the second tongue not insert - press the red button and reinsert the tongues. Check for secure engagement by pulling harness straps.
- (If the harness buckle does not engage correctly, it may require cleaning or seek replacement - refer to page 32)
- D. Ensure slack is removed from harness lap strap by pulling shoulder straps then pull harness adjustment strap to adjust harness to a comfortable but firm fit. Ensure that all slack in harness straps is removed. Shoulder harness straps must fit firmly to the child. Do not over tighten. A loose harness could result in serious injury in an accident.

Do not use restraint if straps do not tighten. Contact your local authorised service agent for repair.



WARNING:

DO NOT LEAVE CHILDREN UNATTENDED IN THE CAR.

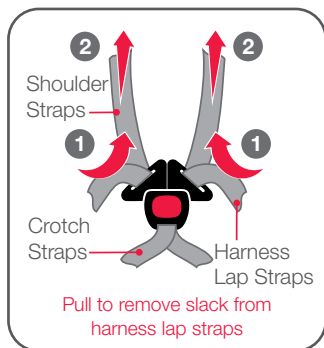
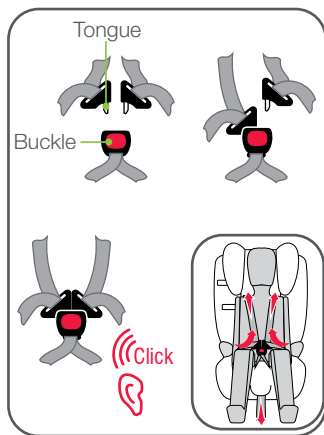

TO REMOVE CHILD FROM RESTRAINT

Press the red harness buckle button, both harness tongues will be released. You may lengthen the harness by pressing the adjuster button or lifting the adjuster lever and pulling the shoulder straps. Move each shoulder strap to the child's side, remove the child. If buckle tongue holders are provided, store the tongues in these.

TO REMOVE RESTRAINT FROM VEHICLE

- A. Disengage seatbelt tongue from buckle and remove from restraint.
- B. Fully press top tether strap adjuster button (A) while pulling top tether strap (B) to slacken as shown right. In some vehicles loosening of the top tether strap may be difficult. If so, try pushing the restraint against the vehicle seat back or slightly lifting the restraint to release the tension.
- C. Disengage the attachment clip from the car's upper anchorage point. Fold up strap and store in pocket provided. The child restraint is now disconnected and can be removed from the car.

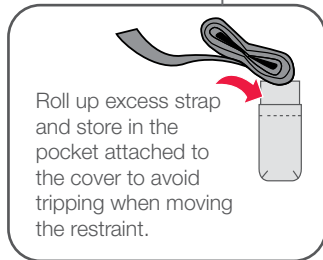
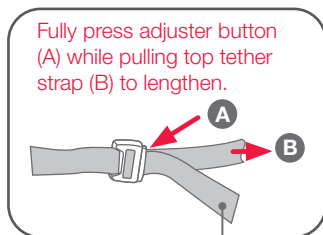

REGULAR CARE OF THIS RESTRAINT:

Please check the following items regularly to ensure the safety of your child:

- A. Check the webbing of the straps for fraying,
- B. Check there are no cracks in moulding,
- C. Check the harness adjuster is operating and is clamping the webbing,
- D. Ensure the buckle is free of fluff, liquid or other matter that may enter the buckle slots.
Clean the buckle if it is sluggish to engage. See next page.
- E. If any part of the restraint is cracked or broken, seek repair immediately
- contact Customer Service 1300 303 330

CLEANING CAR SEAT

Use only mild soap and water to clean all metal and plastic parts of the restraint. Do not use chemicals or cleaning agents.

HARDWARE: Use only mild soap to clean all metal and plastic parts of your child's restraint, using a damp sponge or cloth. Do not use chemicals or cleaning agents. Do not try and place any hardware into a washing machine.

STRAPS/HARNESS: We recommend spot cleaning straps and harness with a damp sponge or cloth using only cold or warm water. Never place any straps or harness into a washing machine or tumble dryer.

BUCKLE OPERATION

To ensure the buckle remains operational the inside of the buckle must be kept free of liquids, sand, dirt, fluff, food or similar substances. If the buckle is not operating or you do not hear a strong audible click when second tongue is inserted then the buckle needs to be washed or replaced. Contact Customer Service for assistance.

TO CLEAN HARNESS BUCKLE:

If sticky liquids such as baby formula, fruit juice, etc. get inside your harness buckle, it may become sluggish. An indication of a sluggish harness buckle is that you cannot hear a click when engaging the harness tongues. To restore the harness buckle to good working order it needs to be cleaned as follows:

- Remove the harness buckle from the restraint:
From the underside of the restraint pull each crotch 3-bar slide then turn the 3-bar slide and push through each slot.
- Place the harness buckle under warm (max. 40 degrees Celsius) running water as shown below. Let the water run through the mouth of the buckle for five minutes. Check the harness buckle is clean by engaging the harness tongues and buckle several times until you hear a click.
- If you still cannot hear a strong audible click then repeat the cleaning process several times.
- Refit the harness buckle to the restraint ensuring the red button facing outwards and the 3-bar slide is fed through the same slots.

If the harness buckle cannot be returned to its original working condition then contact BRITAX Customer Service for assistance.

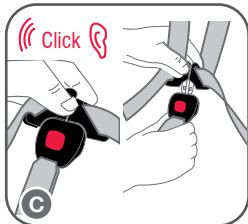
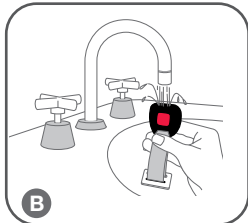
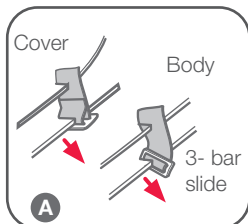

TO CLEAN THE COVER

The restraint has a flame retardant cover which is removable for cleaning. Cleaning instructions are on the care label attached to the cover. When washing cover engage hook & loop strips together to eliminate other garments being caught. Ensure to keep strips free of lint to work effectively.

The cover has been designed to protect your child when seated in the restraint. Care should be taken if children either eat or drink while in the restraint as some food or drink products may cause damage or marking to the cover. Wash or clean immediately.

Do not pull sticky items from covers as the cover may be damaged - soak in water and gently remove.

To keep your product looking its best, take care when using while wearing jewelry or other items that could snag.



VERY IMPORTANT:

Only replace the cover with Safe-n-Sound® supplied replacement cover with identical shoulder height markers or a replacement cover meeting AS/NZS 8005.

TO REMOVE COVER

Remove any accessories eg: padded insert, shoulder pads before removing cover. Follow the sequence below A to G to remove the cover.

A. Disengage harness tongues from crotch buckle.

C. Peel elastic cover away from headrest.

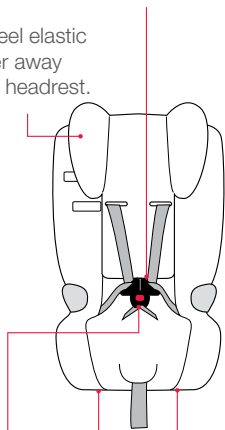

B. Unhook the strap connector from the back of the restraint and feed the shoulder harness straps through the headrest slots and cover, (if applicable) (refer to page 22 for slot height).

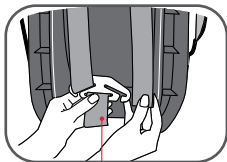

Strap Connector

D. Unhook elastic loops.

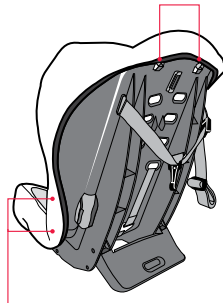

E. Unhook Elastic Loops from under the restraint

G. Peel cover away from seat.

F. Feed crotch buckle and harness adjustment strap through slot in cover, (if applicable).

TO REPLACE COVER

To replace cover refit in reverse sequence G to A.

Use of aftermarket accessories, that is, accessories not provided with this child restraint can reduce the safety of the child restraint and may cause injury or death. Always follow the instructions covering the use of accessories in these instructions or the instructions provided with the accessory. If an aftermarket accessory is used that is not recommended by Safe-n-Sound® then ensure that the accessory is for this restraint and compliant with AS/NZS 8005 and is stated as suitable for use with this child restraint.

The following instructions apply to accessories that may be supplied with this restraint at point of purchase. If not, a variety of BRITAX Safe-n-Sound® accessories are available from various retailers of Safe-n-Sound® products.

CROTCH PAD (IF FITTED)

The Crotch Pad is designed to provide extra comfort for baby or child and is fitted to the restraint as follows: Feed Crotch Buckle through the slot in crotch pad as shown.

PADDED INSERT (IF FITTED)

The Padded Insert is designed to snugly support the baby for extra comfort. Simply place the padded insert on the restraint between Harness straps and the restraint back. Ensure padded insert is lined up with or below the shoulder straps.

Discontinue use if the Insert causes discomfort or when the child's shoulders reach the Middle Shoulder Height Marker. This will allow the child to use the in-built harness longer.

SHOULDER PADS (IF FITTED)

Shoulder Pads are designed to provide extra comfort for baby or child and are easily fitted to the shoulder harness straps by:

- A. Pull apart fasteners and remove shoulder pads from harness.
- B. Re-fit shoulder pads to harness and attach fasteners for use.

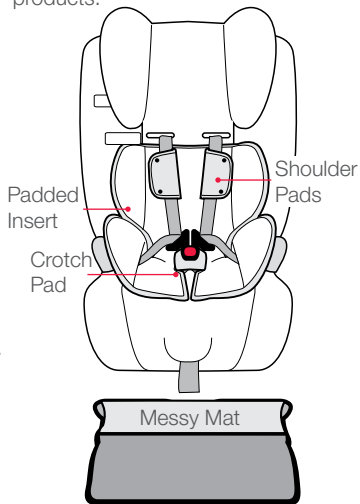

CUP HOLDERS (IF SUPPLIED)

The Child restraint Seat has the facility to fit a cup holder on either side of the seat. Fit the cup holder onto the seat to use. Ensure the cup holder and its contents can not be crushed by the car door. Cup Holder can be removed if not in required.

**IMPORTANT:**

Only use for holding cups, bottles and drink cartons. Do not use for hot drinks.

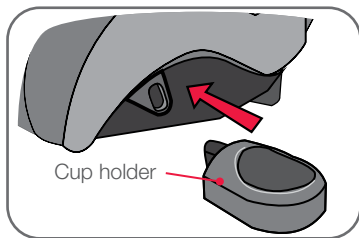
**MESSY MAT SEAT PROTECTOR (IF SUPPLIED)**

Place ribbed or pocket end of the Messy Mat seat protector on edge of car seat, smooth back toward seat join ('A') and fit in any excess Messy Mat into the join of the car seat ('A').

Hook and loop attachment referred in some instruction books, are no longer required to fit this model of Messy Mat seat protector.

**CAUTION:**

The pocket is only for small, light items. DO NOT overload the pocket with heavy, bulky items as this may damage the pocket or cause passengers to trip over them.

Short Messy Mat

Pockets (where fitted)

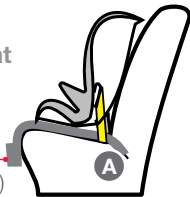
**Long Messy Mat**

Pockets (where fitted)

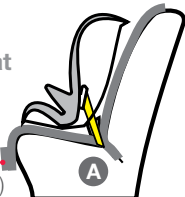

Consult the vehicle owner's handbook for location of anchorage fittings or anchorage points and the possible use of spacers. Some vehicles may have an anchor fitting fitted by the vehicle manufacturer. If anchorage points cannot be found refer to car manufacturer or local child restraint fitting station or traffic authority for preferred position of upper anchorage point.

TOP TETHER STRAP



IMPORTANT:

THE ATTACHMENT CLIP COVER MUST ALWAYS BE USED AS IT PREVENTS THE RISK OF INCORRECT FITMENT OF THE ATTACHMENT CLIP TO THE UPPER ANCHORAGE POINT. ALWAYS ENSURE THAT THE ATTACHMENT CLIP IS CORRECTLY ENGAGED TO THE UPPER ANCHORAGE POINT AND NOT HOOKED OR FITTED TO ANY OTHER OBJECT BEFORE EACH USE OF THE RESTRAINT. THIS IS ESPECIALLY IMPORTANT IN VEHICLES SUCH AS STATION WAGONS, VANS, HATCH BACKS OR VEHICLES WITHOUT A FIXED PARCEL SHELF, SINCE THE ANCHOR POINT IS USUALLY NOT VISIBLE.

IMPORTANT INSTALLATION NOTE:

In some vehicles the upper anchorage point in the rear vertical panel can only be installed in one way. Please refer to vehicle owner's handbook or a child restraint fitting station for correct method.



Front of Vehicle

45°

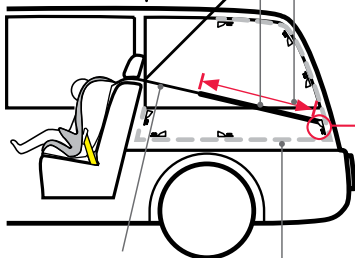

Adjustable Upper
Anchorage Strap

Extension Strap distance to be measured.

Length 300mm (Use BRITAX Safe-n-Sound® part 0035).

Length 600mm (Use BRITAX Safe-n-Sound® part 0036).

Available from all major child restraint retailers.

Measure distance from restraint
upper anchorage attachment clip
to the car anchor fitting.

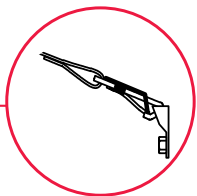

Correct engagement
of attachment clip to
anchor fitting when
attachment clip
cover is used.

The shaded areas of this diagram illustrate the possible locations of the upper anchorage point (car anchor fitting). Within each shaded area is an upper anchorage point showing the correct way to install the fitting. Ensure the upper anchorage point is aligned as illustrated unless stated otherwise in the vehicle owner's handbook.

IF THE CAR IS FITTED WITH CHILD RESTRAINT UPPER ANCHORAGE POINT

Locate the upper anchorage point behind the rear seating position. (Consult the car owners handbook for the location of the upper anchorage point). The upper anchorage point should be directly behind and central to the restraint. Remove thread plug from the parcel shelf/floor/roof, etc. and install attachment bolt and fitting as shown in Fig 1.

CAUTION: DO NOT OVERTIGHTEN ATTACHMENT BOLT. OVERTIGHTENING MAY FRACTURE OR BREAK BOLT. MAXIMUM TORQUE IS 20 Nm(14.75 ft.lb.)

Note: Minimum of five full turns of attachment bolt is required before tightening force is applied.

Fig.1.

UPPER ANCHORAGE FITTING

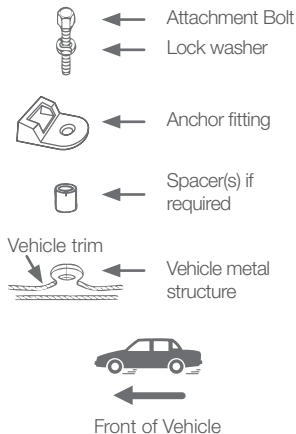

IF THE CAR IS NOT FITTED WITH CHILD RESTRAINT UPPER ANCHORAGE POINTS

FOR SEDANS ONLY - Drill 9mm diameter hole in the parcel shelf on the centre line of the seating position as shown in Fig 3. Before drilling the hole, check the underside for accessibility. Install the attachment bolt as shown in Fig 2. It is recommended that this installation be carried out by a child restraint fitting station or licenced motor mechanic.

FOR VEHICLES OTHER THAN SEDANS

- In Australia, consult your nearest child restraint fitting station or traffic authority for vehicle inspection to find the best, correct position for the placement of the upper anchorage point, and for the correct attachment bolt length and use of spacers. In New Zealand, consult the agent for the vehicle. Note to Queensland purchasers: The installation of anchorage points must be approved by authorised officers appointed by Queensland Transport. Authorised officers can be sourced from all Queensland Transport Customer Service and Queensland Ambulance Service Centres.

Fig.2.

UPPER ANCHORAGE FITTINGS FOR SEDANS ONLY

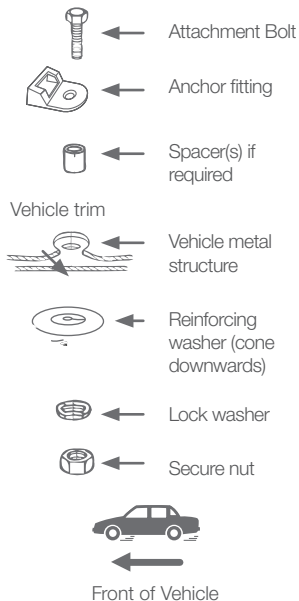

ONLY USE A 5/16 UNC GRADE 5 BOLT. IF THE BOLT IS NOT THE CORRECT LENGTH THE CAR MANUFACTURER'S HAND BOOK CAN PROVIDE ADVICE ON THE CORRECT LENGTH BOLT.



Note: Marking on the top of a Grade 5 Bolt.



WARNING

CHILD RESTRAINTS MUST NOT BE ATTACHED TO UNSOUND METAL OR TO WOOD, OR SYNTHETIC STRUCTURES. WHEN DRILLING 9 MM HOLE DO NOT DRILL THROUGH FUEL LINES, FUEL TANKS, ELECTRICAL WIRING, OR RADIO SPEAKERS. WEBBING STRAPS MUST BE PROTECTED FROM SHARP CORNERS AND EDGES. THE ANCHOR FITTING MUST BE USED ONLY AS DESCRIBED ABOVE. IT MUST NOT BE HOOKED ONTO ANY OTHER OBJECT.

CAR INSTALLATION ACCESSORIES

(From retailers of Britax Safe-n-Sound® products)

EXTRA ANCHOR KITS: Available for using the restraint in additional cars.

Re-order no: 0038

EXTENSION STRAPS: May be required for cars without a fixed parcel shelf.

Re-order no: 0035 (length 300mm) or 0036 (length 600mm)

Fig.3.

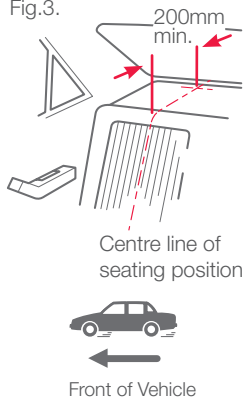

If your restraint has been involved in a severe crash, you should destroy the restraint even if no damage is obvious. Some insurance companies offer vehicle insurance which covers or partially covers the replacement of your child restraint. Contact your insurance company for further details. Your insurance company may require you to keep the child restraint for assessment, **but do not use the child restraint after a severe crash**. To assist you in making an accident insurance claim cut the following statement and include it with your claim.

NOTICE TO INSURANCE COMPANY CHILD RESTRAINT INVOLVED IN AN ACCIDENT

All Britax Safe-n-Sound® child restraints are manufactured to Australian/New Zealand Standards AS/NZS1754-2013 which require us to advise users of child restraints to "Destroy the entire restraint if it has been in use in a severe crash, even if no damage is obvious". The joint Australian/New Zealand Standards committee CS/85, advise that this statement applies whether a child was in the child restraint or not. A severe crash, we consider as being one where the main body structure of the vehicle is distorted.

There is no method of determining if the restraint has been damaged and we concur with the Australian/New Zealand Standards in recommending destruction of the child restraint.

This notice is to advise you of the requirements of the Australian/New Zealand Standards and our obligation in complying with the standards.

Please assist the owner of this restraint in their claim.

Britax Childcare Pty. Ltd.

(Incorporated in Victoria)

A.B.N 55 006 773 600

Head office and registered address:

Level 4, 650 Lorimer Street, Port Melbourne, VIC, 3207

P.O. Box 5119 Garden City, VIC, 3207

Telephone: 1300 303 330

New Zealand Office:

Britax Childcare NZ Limited.

PO Box 100-247 Auckland 9

Telephone: 0508 688 822



We would never want you to experience an accident, but unfortunately accidents do happen.

If you experience an accident you may be eligible for a free replacement.

The Britax Safe-n-Sound® Crash Exchange Program is a voluntary program designed to ensure that our children are safe and that any seat that may have experienced a severe crash is taken out of the market.

There is no method of determining if the restraint has been damaged in a severe crash, so the restraint should be destroyed as the crash may reduce the child restraints ability to perform.

Since its inception in 2006, the Crash Exchange program has helped 100's of families ensure that their children have new restraints and that the restraints are not sold second hand placing others at risk.

Our Crash Exchange Terms and Application form are accessible on our website. Please visit www.britax.com.au for further information.



AUSTRALIA

Britax Childcare Pty. Ltd.

A.B.N 55 006 773 600

Head office and registered address:

Level 4, 650 Lorimer Street, Port Melbourne, VIC, 3207

P.O. Box 5119 Garden City, VIC, 3207

Customer Service 1300 303 330

Email au-support@britax.com

www.britax.com.au

NEW ZEALAND

Britax Childcare (NZ) Ltd.

Customer Service 0508 688 822

Email nzoffice@britax.com

www.britax.com.nz

INTERNATIONAL ENQUIRIES

Contact your local Distributor











Series No. BS090GA-020133
Scan QR code for features,
how to use and installation.

WARRANTY

Our goods come with guarantees that cannot be excluded under the Australian Consumer Law. You are entitled to a replacement or refund for a major failure and compensation for any other reasonable foreseeable loss or damage. You are also entitled to have the goods repaired or replaced if the goods fail to be acceptable quality and the failure does not amount to a major failure.

For the full terms of the Warranty refer to the Britax website
www.britax.com.au/service-support/warranty

In our constant pursuit of excellence we may alter this product and specification without notice. This product may be covered by Australian and International patents and designs or pending applications. Safe-n-Sound® is a registered trademark and all Safe-n-Sound® model names are trademarks of Britax Childcare Pty Ltd.