

britax
safe·n·sound
CHILD HARNESS
FOR BOOSTER SEATS

Series No. 220/2013

Suitable for compatible Booster Seats
and Convertible Booster Seats

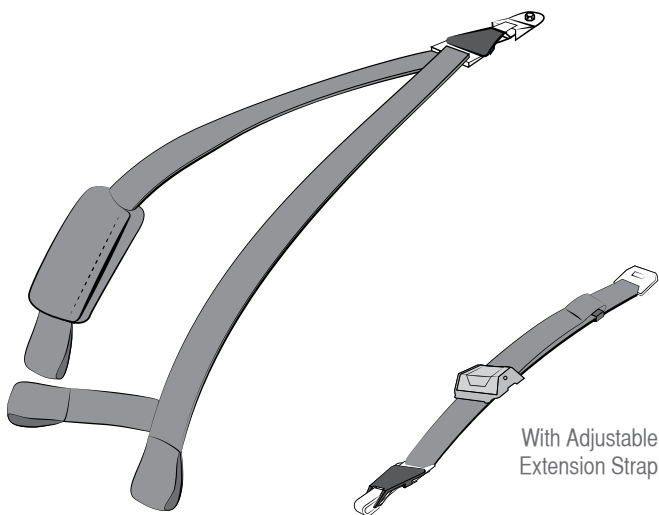

**IMPORTANT: KEEP THIS BOOKLET IN A
PLACE FOR FUTURE REFERENCE**

INDEX

PAGE

- 3** INTRODUCTION
- 4** INFORMATION
- 5** WARNINGS
- 6** SUITABLE FOR USE
- 7** HOW TO INSTALL & USE
- 21** CORRECT FITMENT
- 22** NEXT TYPE OF RESTRAINT
- 23** INSTALLATION OF CAR'S UPPER ANCHORAGE POINT
- 27** ACCESSORIES & MAINTENANCE
- 30** IN CASE OF ACCIDENT
- 31** CONTACT DETAILS

INTRODUCTION

This child harness is suitable for children from approximately 4 years of age together with a compatible booster seat until the child's shoulder reaches the upper shoulder height marker of the booster seat.

This child harness must not be used without a compatible booster seat.

Children are safest in a booster seat once they have out grown their restraint with in-built harness.

Children should continue to use a booster until their shoulders reach the upper shoulder height marker.

Do not use this child harness until the child's shoulders are above the lower shoulder height marker on the booster seat.

If the knees do not bend in front of the vehicle seat cushion continue to use a booster seat.

The Child Harness has been specifically designed for use with a **VERSATETHER™** compliant Booster Seat and Convertible Booster Seat to provide a safe and secure fit for the child. The Child Harness is also suitable for use with booster seats or booster cushions not made to AS/NZS1754:2013 but earlier standards. For any other booster seat, check the booster seat instruction book for any limitation of use of a child harness.

Correct use of this product can reduce a child's risk of injury if a seatbelt is not worn correctly.

This restraint must be used with a lap or lap-sash seatbelt in accordance with these instructions.

THIS RESTRAINT MUST BE ATTACHED TO A CHILD RESTRAINT ANCHORAGE POINT IN THE CAR. REFER TO CAR OWNERS HANDBOOK FOR LOCATION OF ANCHORAGE POINTS. REFER TO A CHILD RESTRAINT FITTING STATION IF NO ANCHORAGE POINTS ARE IN THE MOTOR CAR.

WHEN USED WITH A BOOSTER SEAT OR CONVERTIBLE BOOSTER SEAT THEN THE LAP SEATBELT MUST BE USED WITH A CHILD HARNESS. A CHILD HARNESS MAY BE USED WITH A LAP-SASH SEATBELT.

These instructions show the installation of the Child Harness for use with a Booster Seat or Convertible Booster Seat and a lap or lap-sash seatbelt (page 7).

Britax Safe-n-Sound recommend that all Booster Seats and Convertible Booster Seats use the SLIDEGUARD™ clip or lap belt positioning device to ensure the Child Harness fits correctly and the child does not slump under the car's lap seatbelt. The lap seatbelt on the child's abdomen is dangerous. This child harness may not be suitable for use in countries other than Australia or New Zealand due to differing standards for child restraints. Consult with the country's local authorities, car hire companies, car insurance companies for advice.

TO BE USED WITH A LAP SASH/LAP ONLY SEATBELT IN THE BACK OF MOST CARS WITH FORWARD FACING SEATS.

INFORMATION

CAREFULLY READ AND FOLLOW ALL OF THE INSTRUCTIONS FOR INSTALLATION. INSTALL IN STRICT ACCORDANCE WITH THESE INSTRUCTIONS FOR MAXIMUM SAFETY. IF IN DOUBT ABOUT THE CORRECT METHOD OF INSTALLATION PLEASE CONTACT BRITAX CHILDCARE, OR AGENT OR A CHILD RESTRAINT FITTING STATION AUTHORISED BY THE STATE GOVERNMENT BODY. IN NEW ZEALAND, CONTACT THE AGENT FOR THE VEHICLE.

No child restraint can guarantee absolute protection from injury in every crash. However, to ensure that your child gets all the protection designed into the Child Harness please READ AND FOLLOW THESE INSTRUCTIONS EXACTLY and use only Safe-n-Sound recommended parts and accessories.

This Child Harness may be used in conjunction with Booster Seats and Convertible Booster Seats that recommend this Child Harness. Some Safe-n-Sound™, Babylove™, Hipod™ and Cargo™ child restraints only use this harness. Read the Booster Seat or Convertible Seat instruction book or packaging to confirm which harness you need.

TOP TETHER ANCHORAGE

This Child Harness requires the top tether strap to be connected to a child restraint anchor fitting in the car. Recent cars may include an anchor fitting. Some cars will require the fitting to be installed. Check your car owners handbook for the location of the car's child restraint anchor fitting or anchorage point. If there is no fitting then read pages 25 -27. An anchor fitting is provided with this product.



CHOOSING METHOD OF INSTALLATION

The harness may be used with compatible Booster Seats or Convertible Booster Seats, using either the car's lap only seatbelt or the lap sash seatbelt until the child is too large for the booster seat, that is, the child's shoulders reach the Upper Shoulder Height Marker.



**IMPORTANT: Do not use with just a seatbelt.
Only use with a compatible booster seat and not
recommended for use with a lap-sash seatbelt.**



WARNINGS

Use the restraint exactly as shown in the instructions.

Supervision of children is needed because they may be able to undo the buckles & adjusters.
DO NOT LEAVE CHILDREN UNATTENDED IN THE CAR.

Do not alter or modify this restraint.

Repairs must only be done by the manufacturer or agent.

Do not allow the restraint to come into contact with polishes, oils, bleach & other chemicals.

DO NOT USE THE RESTRAINT WITHOUT THE COVER.

Destroy the restraint if it has been in a severe crash, even if no damage is visible.

The lap belt must be adjusted firmly first, and then the harness, so that the belt is not lifted off the child's lap when the harness is adjusted.

FOR BOOSTER CUSHION: DO NOT USE THIS HARNESS IF THE CHILD'S SHOULDERS ARE ABOVE THE TOP OF THE CAR SEATBACK OR HEADREST.

Do not use the extension strap supplied for any other purpose.

Always secure the loose end of the top tether strap. Do not use the child restraint where this strap may fall into a split in the seat back or off the side of the seat.

ALWAYS ATTACH HOOK AND REMOVE SLACK.

INSTALLATION AND USE

THIS RESTRAINT MUST BE ATTACHED TO A CHILD RESTRAINT ANCHORAGE POINT IN THE CAR. REFER TO CAR OWNERS HANDBOOK FOR LOCATION OF ANCHORAGE POINTS. REFER TO A CHILD RESTRAINT FITTING STATION IF NO ANCHORAGE POINTS ARE IN THE MOTOR CAR.

A seatbelt extender should not be used if the seatbelt is not long enough to secure the child. If a seatbelt extender is used then the buckle must not be in contact with the child.

THIS RESTRAINT IS NOT SUITABLE FOR USE WHERE THE TOP TETHER MAY FALL INTO A SPLIT IN THE SEAT BACK OR OFF THE SIDE OF THE SEAT.

SUITABLE FOR USE

TO BE USED WITH A LAP OR LAP-SASH SEATBELT IN THE BACK OF MOST CARS WITH FORWARD-FACING SEATS.

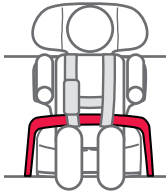
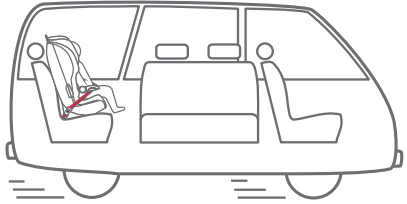

Lap Only belt

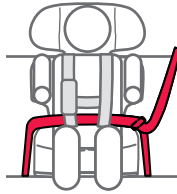

Lap/Sash belt

NOT SUITABLE FOR USE

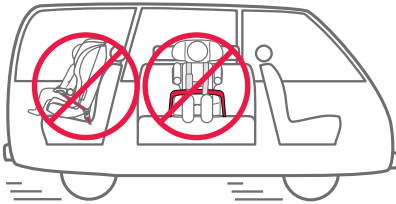

Do not use on any vehicle seat which faces sideways or rearwards.

Regional Road Rules may prohibit the use of this restraint in the front seat until the child is 4 years of age. Check your regional road rules for exemptions.

PARTS SUPPLIED IN THE PACKAGE:

- Child Harness
- Anchor fitting, bolt and spacers.
- Adjustable Extension Strap
- Gated 3 bar slide
- Instruction Booklet

HOW TO INSTALL & USE

USING WITH A BOOSTER SEAT OR CONVERTIBLE BOOSTER SEAT

The Child Harness is suitable for Booster Seats and Convertible Booster Seats for seating positions where a child restraint anchorage is provided. Refer to the car's owners manual for positions.

These instructions provide details for installing the Child Harness with a Booster seat for a vehicle with either a lap only seatbelt or a lap-sash seatbelt.

If an anchor fitting is required refer to pages 23 to 25. The following instructions provide details of how the Harness can be used with a typical Booster Seat. The Child Harness is suitable for the harness straps to feed through the slots in the seat or over the top of the seat in accordance with the Booster Seat's instructions.

ALWAYS FOLLOW THE BOOSTER SEAT OR CONVERTIBLE BOOSTER SEAT INSTRUCTIONS AND LABELLING.

INSTALLING THE HARNESS TO THE BOOSTER SEAT OR CONVERTIBLE BOOSTER SEAT WITH SLOTS FOR CHILD HARNESS

Booster Seats and Convertible Booster Seats fitted with the **VERSATETHER™** connection system may require the Child Harness to be threaded through slots in the seat. Follow the seat's instructions. The following are general instructions.

Decide which seating position you are going to use and which seatbelt type is installed in that position (if using a lap-sash seatbelt then a Gated Slide must be used).

- A. Ensure any headrest is set to the correct height for your child.
- B. Hook the attachment clip to the anchor fitting and tighten.

Hook top tether attachment clip to the anchor fitting in the Car

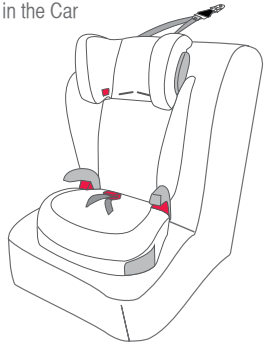

HOW TO INSTALL & USE

- C. Lengthen the Child Harness using the adjuster under the cover (see the Child Harness instructions on the adjustment method). Press the Adjuster button (1) on the adjuster and pull the shoulder strap (2). **Right and left hand are referenced as seen by the child in the seat.**

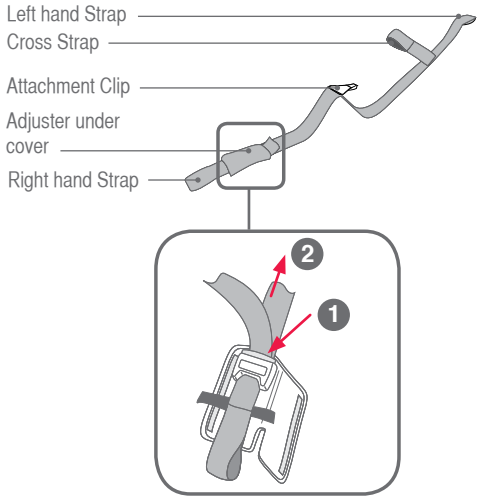

- D. Feed the left hand harness strap and attachment clip through the right hand slot of the booster seat headrest or seat cover. (Refer to the seat's instruction book).

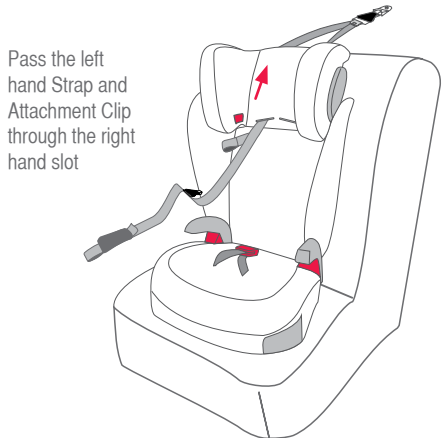

HOW TO INSTALL & USE

- E. Hook the Attachment Clip from the Child Harness onto the VERSATETHER™ Catch, then pass the left hand harness strap through the left hand slot of the booster seat. Page 11 shows connection of the Child Harness to the anchor fitting on the parcel shelf. Page 12 shows connection of the Child Harness to the extension strap and then the anchor fitting in the car such as a wagon or hatchback.

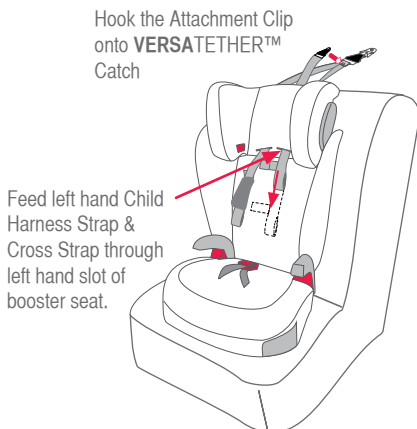

- F. The seat is now ready to fit the seatbelt and the Child Harness to the child.

For attachment of Upper anchorage strap:

Refer to pages 10 & 12 - For Booster seat **with** **VERSATETHER™** Catch system.

Refer to pages 13 & 17 - For converting a lap-sash seatbelt.

Refer to pages 18 to 19 - For fitting the Child Harness with either a lap or converted lap-sash seatbelt.

- G. If your seat is a Convertible Booster Seat the next page shows a similar method of setting up the seat.

HOW TO INSTALL & USE

FITTING CHILD HARNESS TO CONVERTIBLE BOOSTER SEATS FITTED WITH THE VERSATETHER™ SYSTEM.

- A. Feed the left hand Harness Strap & Cross Strap through the appropriate shoulder slot for your child's size. If the seat is fitted with an Adjustable Headrest then thread the harness through the slots in the headrest. (Refer to the seat's instruction book for full details).

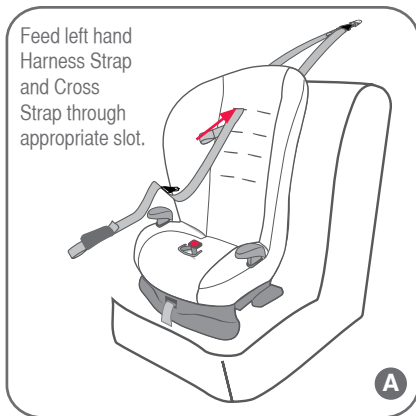

- B. Pull the left hand Harness Strap & Cross Strap through the opposite shoulder slot. Make sure that the Anchor Clip also feeds through to the back of the restraint. Hook the Attachment Clip onto the **VERSATETHER™** Catch and ensure that the straps line up to an equal length.

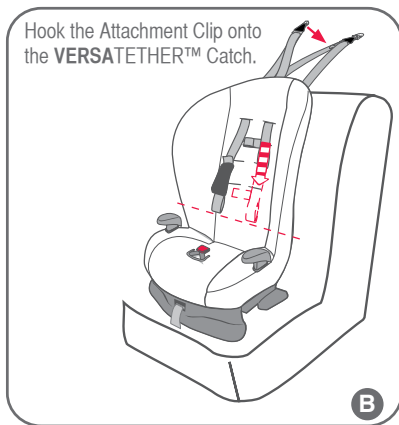

- C. These are generic instructions so reference to the instructions for the Convertible Booster Seat is essential. Some Convertible Booster Seats may have an adjustable headrest. The previous pages may provide a guide for installation.

Always adjust the height of the shoulder straps as the child grows.

HOW TO INSTALL & USE

INSTALLING INTO VEHICLE WITHOUT EXTENSION STRAP

Hook the Child Harness attachment clip (1) onto **VERSATETHER™** Catch (2). Then hook attachment clip (3) onto anchor fitting. Ensure that none of the straps are twisted and not passing over any sharp edges.

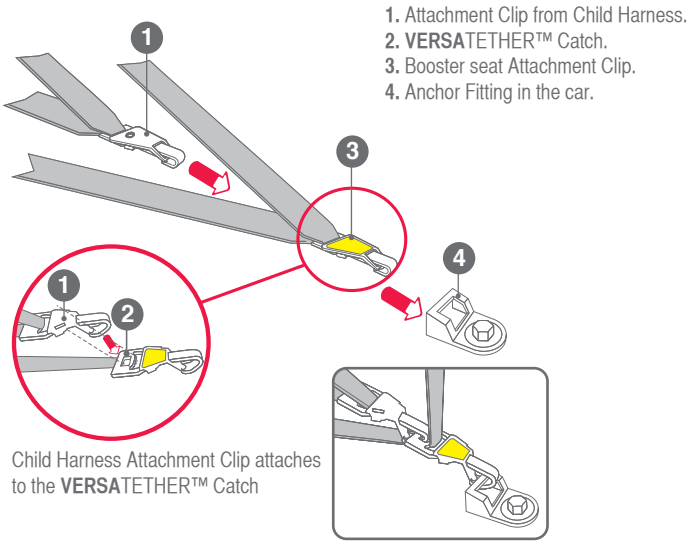

Older Booster Seats and convertible booster Seats may have a strap for connecting the Child harness.

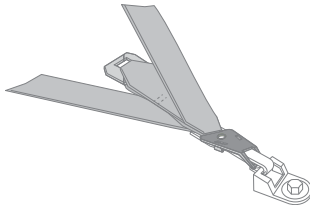

! CAUTION:
CHILDREN CAN BE INJURED OR RESTRAINTS AND TOP TETHER STRAP DAMAGED BY UNSECURED CARGO IN A COLLISION. SECURE OR REMOVE HAZARDOUS CARGO BEFORE USING THIS CHILD RESTRAINT.

HOW TO INSTALL & USE

INSTALLING INTO VEHICLE WITH EXTENSION STRAP

An Adjustable Extension Strap is supplied with the Harness. Hook the Safe-n-Sound child harness clip (1) onto the extension strap catch (6), then hook the extension strap clip (7) onto the **VERSATETHER™** Catch on the Booster Seat's upper anchorage strap (3) as shown below. Remove excess slack from the Extension Strap by pulling the adjuster strap as illustrated below.

1. Attachment clip from the Child Harness
2. **VERSATETHER™** Catch
3. Booster Seat Attachment Clip
4. Anchor Fitting in the Car
5. Adjustable Extension Strap
6. Extension Strap Catch
7. Extension Strap Attachment Clip

Attachment Clip attaches to the **VERSATETHER™** Catch

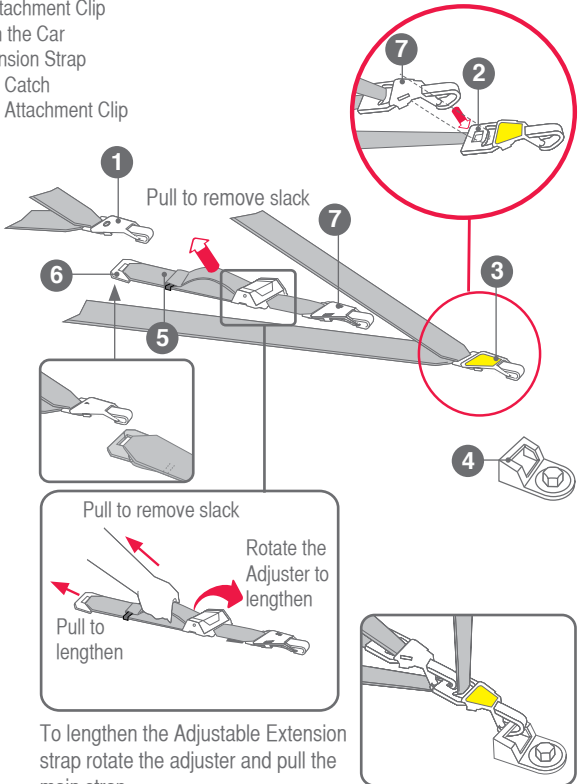

To lengthen the Adjustable Extension Strap rotate the adjuster and pull the main strap.



WARNING:

Always attach the hook and remove the slack.

HOW TO INSTALL & USE

FOR USE WITH A LAP-SASH SEATBELT AND BOOSTER SEAT

There may be one of two types of Gated Slides available as shown below provided with this harness. Only use Gated Slides recommended for this Harness.

If curved Gated Slide, then the belt route through this can only go one way as shown.

Before using the Child Harness with a Lap-Sash Seatbelt, you need to convert the seatbelt to a Lap Seatbelt by using the Gated Slide provided.

IMPORTANT: Face the hollow side of the Gated Slide towards the child. Do not use Gated Slide for any other purpose.

Curved



Flat

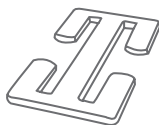

Always ensure the Hollow side is towards child

- A. Hold the lap and sash straps together and fold as shown below. Slide the inner strap into the Gated Slide followed by the outer strap.

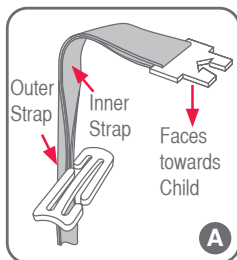

- B. The two straps should slide freely in the Gated Slide slot.

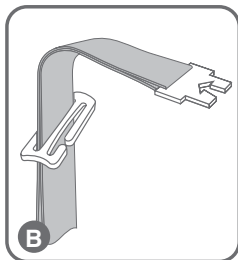

HOW TO INSTALL & USE

C. Repeat previous step A for the other slot in the Gated Slide.

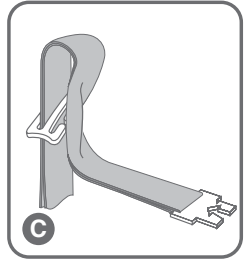

D. Feed the straps through the Gated Slide to remove any slack. This has now converted the lap-sash seatbelt so it will act like a lap only seatbelt.

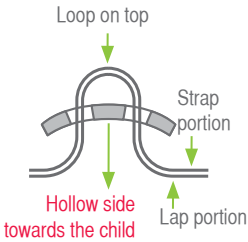
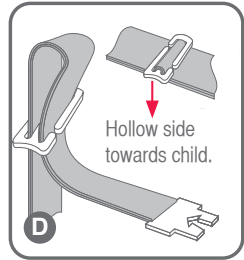

TO ENSURE CORRECT CONVERSION OF LAP-SASH SEATBELT TO LAP SEATBELT FOLLOW THESE STEPS.

E. When installing a converted lap-sash belt (using a gated slide) ensure the fitted lap strap has all slack removed to position correctly on the child's thighs.

F. Ensure the connected lap belt has no twists in the webbing.

IMPORTANT:

The Gated Slide must be removed from the seatbelt if the booster seat and child harness are no longer used in the car so that other users can use the seatbelt as a lap sash seatbelt.

A seatbelt extender should not be used if the seatbelt is not long enough to secure the child. If a seatbelt extender is used then the buckle must not be in contact with the child.

HOW TO INSTALL & USE

HARNESING THE CHILD INTO THE BOOSTER SEAT

These instructions apply to fitting with a lap only seatbelt or a converted lap-sash seatbelt.

1. Left Hand Harness Strap
2. Right Hand Harness Strap
3. Storage strap
4. Cover Pad
5. Harness Strap Loops
6. Cross Strap Loop
7. Cross Strap

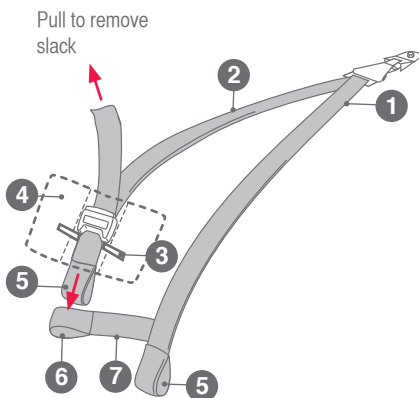

- A. With the child seated, place each of the harness straps over each shoulder.
- B. Feed the right hand strap (loop end) into the cross strap loop to connect the two sides.
- C. Feed the adult belt (lap belt or converted lap/sash) through the harness loops, ensuring that the cross strap loop does not disconnect. Also ensure there are no twists in the harness, cross strap and seatbelt.

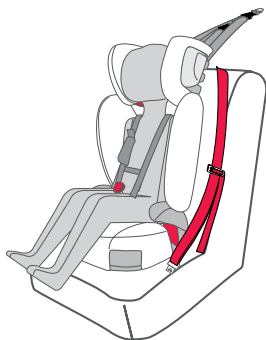

Thread the converted lap-sash seatbelt or lap seatbelt through the harness strap loops as shown.

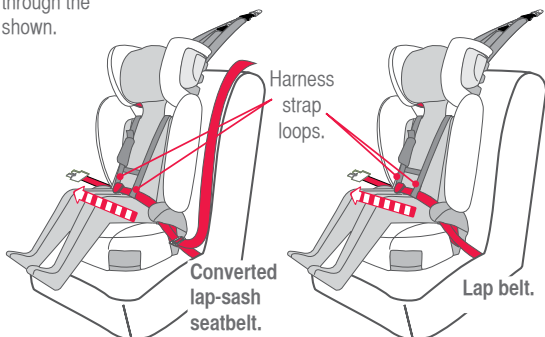

HOW TO INSTALL & USE

- D. Engage the seatbelt tongue to the buckle and adjust the seatbelt to sit firmly around the child's hips and thighs. The seatbelt buckle should be located as low as possible below the child's hip. If using a lap-sash seatbelt and Gated Slide you will need to adjust it so that the seatbelt is firm on the child's thighs and the Gated Slide is close to the Child but not touching the child.

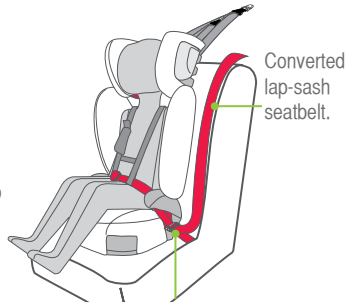

The Gated Slide needs to be close to the child but not touching the child. If armrests are included the Gated Slide needs to be under the armrest.

SLIDEGUARD™ clip
(or Lap Belt Positioning
Device)

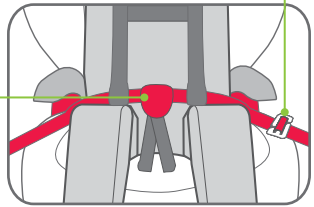

- E. Fit the SLIDEGUARD™ clip.

ALWAYS USE THE LAP BELT POSITIONING DEVICE

- F. Adjust the Child Harness to remove slack in the shoulder straps. Pull the Adjuster Strap (C) to remove slack.

Once adjusted, further adjustments are necessary only to the upper extension straps and to accommodate the growth of the child.

Press (A) and pull the shoulder strap (B) to lengthen.

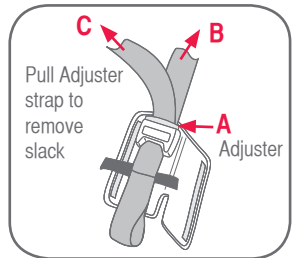

Fully press adjuster button (A) while pulling the Upper Anchorage Strap (B) to lengthen.

WARNING:

DO NOT LEAVE CHILDREN UNATTENDED IN THE CAR.

HOW TO INSTALL & USE

- G. Roll up the free end of the adjuster strap, secure using the storage strap, then place it into the top of the adjuster cover as shown above and fasten the storage strap.

Fold the adjuster strap and secure with Storage Strap.

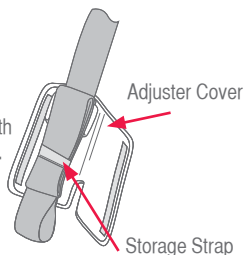

! IMPORTANT :

Always secure the loose end of the top tether strap to prevent it hanging out of the car or being accessible by the child.

- H. To release the child, see page 22. In some installations the seatbelt may need to be taken out of the Strap Loops.

FITTING CHILD HARNESS ONTO BOOSTER SEATS & BOOSTER CUSHIONS

If using the harness with a Booster seat or Convertible Booster Seat where there are no slots for the child harness, the child harness will need to be fitted as per the seat instructions. This may require the harness to be placed over the top of the seat and the harness may be threaded through a guide if possible.

- A. With Booster seats and Booster Cushions the Child Harness shoulder straps sit over the top of the seat back or the car's seat back as shown in the diagram on the right.
- B. Hook the Child Harness Attachment Clip to the anchor fitting.
- C. Pull the left hand and right hand Harness Straps so that they are equal in length.
- D. Follow installation instructions on 17 and 18 for how to fit the car's seatbelt to the Child Harness.

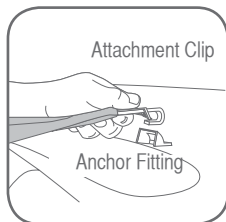
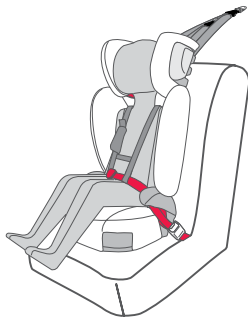

HOW TO INSTALL & USE

CHILD HARNESS WITH BASIC AND OLDER BOOSTER SEAT OR BOOSTER CUSHION

USING LAP SASH SEATBELT

Thread the converted lap-sash seatbelt through the harness strap loops as shown.

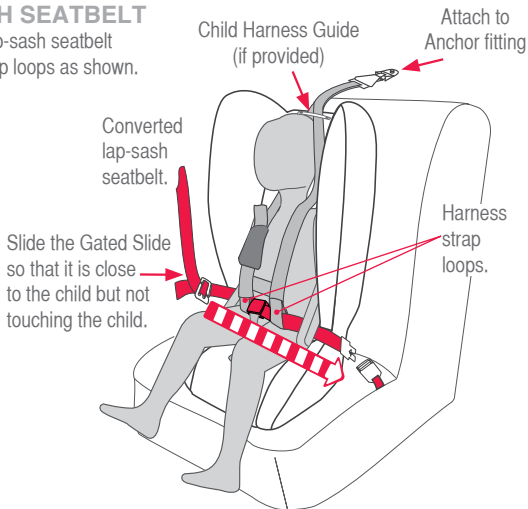

USING LAP ONLY SEATBELT

Thread the lap seatbelt through the harness strap loops as shown.

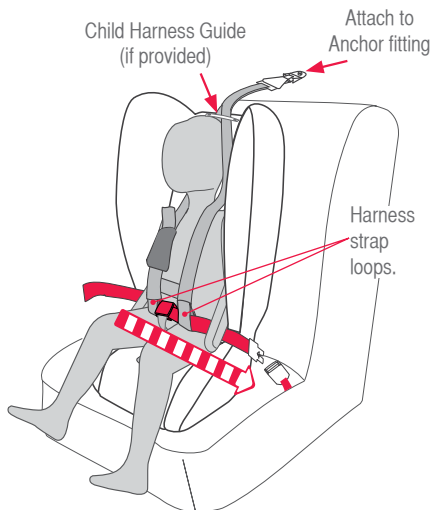

HOW TO INSTALL & USE

Thread the harness through any guides or slots on the booster seat, (refer to booster seat instructions).

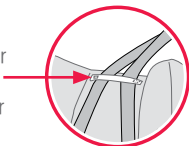

Lap belt or converted lap-sash seatbelt. Connect Lap Belt positioning devices if any.

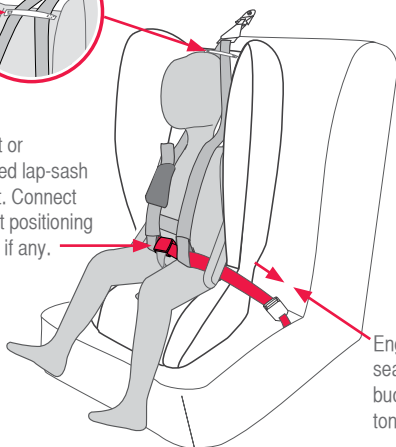

Engage seatbelt buckle and tongue.

USE WITH A BOOSTER CUSHION

Shoulders must not be above the top of the car's seat back or headrest.

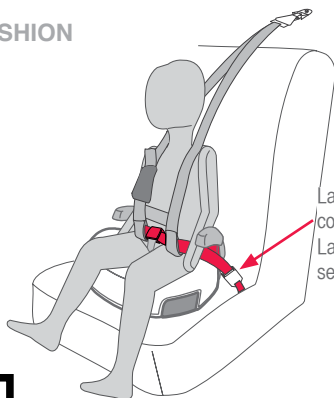

Lap or converted Lap-sash seatbelt



WARNING:

DO NOT LEAVE CHILDREN UNATTENDED IN THE CAR.

ALWAYS USE THE LAP BELT POSITIONING DEVICE

DO NOT USE THIS HARNESS IF THE CHILD'S SHOULDERS ARE ABOVE THE TOP OF THE CAR SEAT BACK OR HEADREST.

NOTE: REFER TO PAGE 19 ADJUSTING CHILD HARNESS

HOW TO INSTALL & USE

TO REMOVE CHILD FROM HARNESS AND SEAT

Disengage seatbelt tongue and buckle, remove the lap portion of seatbelt from the SLIDEGUARD™ clip (where provided) and remove Child Harness and seatbelt from child.

NOTE: It may be easier to unthread the car seatbelt out of the loops before lifting the child harness over the child's head.

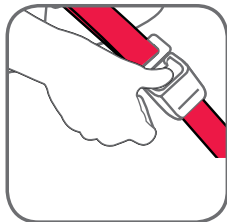

Lift child harness strap over child's head.

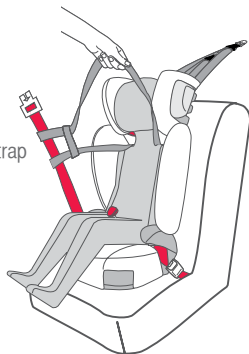

IMPORTANT:

The Gated Slide must be removed from the seatbelt if the booster seat and child harness are no longer used in the car so that other users can use the seatbelt as a lap sash seatbelt.

CORRECT FITMENT

CHILD HARNESS AND BOOSTER SEAT

If the seat is fitted with a Lap Belt Positioning Device like SLIDEGUARD™clip, always use it. It will help prevent the child slumping or the seatbelt riding up on to the child's abdomen.

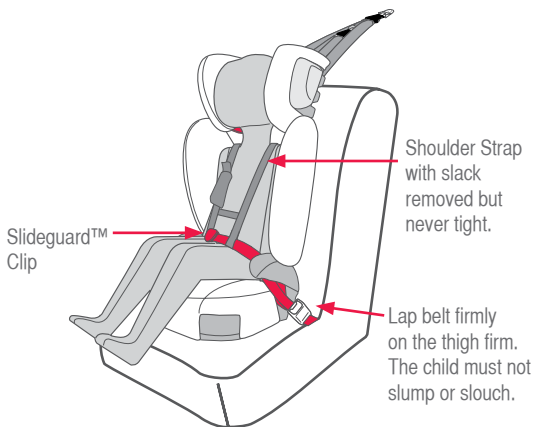

CAUTION:

ALWAYS FOLLOW THE BOOSTER SEAT OR CONVERTIBLE BOOSTER SEAT INSTRUCTIONS AND LABELLING. FOLLOW SEATBELT PATHS.



IMPORTANT:

Use seatbelt to hold the child restraint when not in use.
ALWAYS USE THE SLIDEGUARD™CLIP OR LAP BELT POSITION DEVICE.

NEXT TYPE OF RESTRAINT

NEXT TYPE OF RESTRAINT THAT CAN BE USED IN THE CAR FOR YOUR CHILD.

If you are using a booster seat and the child's shoulders have reached the top shoulder height marker then you need a larger booster seat or the car's seatbelt.

When the child reaches 45kg then they need to discontinue using the child harness, and use the car's seatbelt.

EACH REGION HAS ROAD RULES THAT REQUIRE A CHILD TO BE PROPERLY RETAINED. ALWAYS FOLLOW THE RULES.

If your child has outgrown the booster seat they can use a larger booster seat suitable for children up to 8 to 10 years of age, or they can use the car's 3 point sash and lap seatbelt. The seatbelt must be correctly fitted.

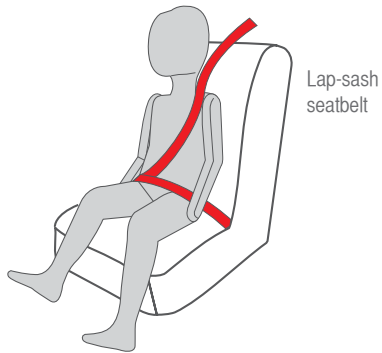

INSTALLATION OF CAR'S UPPER ANCHORAGE POINT

Consult the vehicle owner's handbook for location of anchorage fittings or anchorage points and the possible use of spacers. Some vehicles may have an anchor fitting fitted by the vehicle manufacturer. If anchorage points cannot be found refer to car manufacturer or local child restraint fitting station or traffic authority for optimum position of anchorage point and the use of spacers.

UPPER ANCHORAGE STRAP



IMPORTANT:

THE ATTACHMENT CLIP COVER MUST ALWAYS BE USED AS IT PREVENTS THE RISK OF INCORRECT FITMENT OF THE ATTACHMENT CLIP TO THE ANCHOR FITTING. ALWAYS ENSURE THAT THE ATTACHMENT CLIP IS CORRECTLY ENGAGED TO THE ANCHOR FITTING AND NOT HOOKED OR FITTED TO ANY OTHER OBJECT BEFORE EACH USE OF THE RESTRAINT. THIS IS ESPECIALLY IMPORTANT IN VEHICLES SUCH AS STATION WAGONS, VANS, HATCH BACKS OR VEHICLES WITHOUT A FIXED PARCEL SHELF, SINCE THE ANCHOR POINT IS USUALLY NOT VISIBLE.

IMPORTANT INSTALLATION NOTE:

In some vehicles the anchor fitting in the rear vertical panel can only be installed in one way. Please refer to vehicle owner's handbook or a child restraint fitting station for correct method.

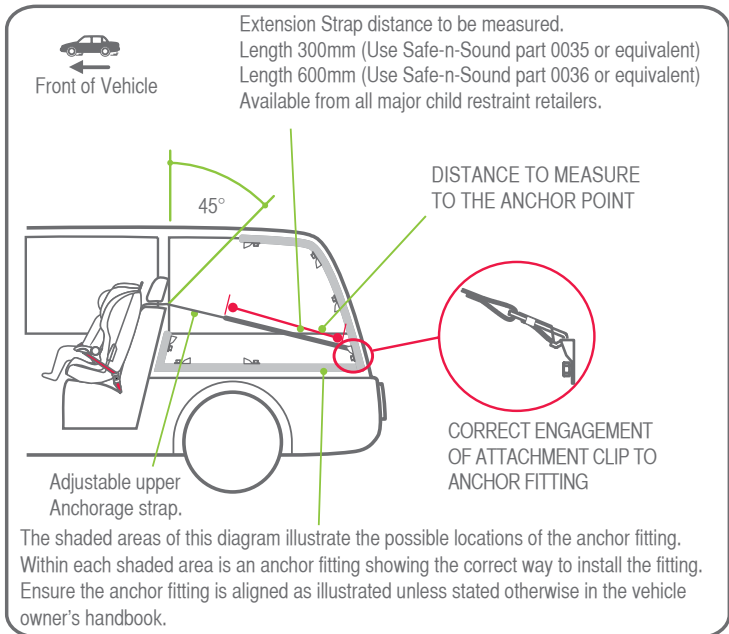

INSTALLATION OF CAR'S UPPER ANCHORAGE POINT

IF THE CAR IS FITTED WITH CHILD RESTRAINT UPPER ANCHORAGE POINT

Locate the upper anchorage point behind the rear seating position. (Consult the car owners handbook for the location of the upper anchorage point). The upper anchorage point should be directly behind and central to the restraint. Remove thread plug from the parcel shelf/floor/roof, etc. and install attachment bolt and fitting as shown in Fig 1.

CAUTION: DO NOT OVERTIGHTEN ATTACHMENT BOLT. OVERTIGHTENING MAY FRACTURE OR BREAK BOLT. MAXIMUM TORQUE IS 20 Nm(14.75 ft.lb.)

Note: Minimum of five full turns of attachment bolt is required before tightening force is applied.

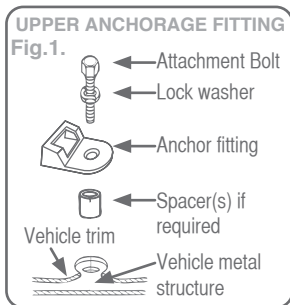

IF THE CAR IS NOT FITTED WITH CHILD RESTRAINT UPPER ANCHORAGE POINTS

For Sedans only - Drill 9mm diameter hole in the parcel shelf on the centre line of the seating position as shown in Fig 3. Before drilling the hole, check the underside for accessibility. Install the attachment bolt as shown in Fig 2. It is recommended that this installation be carried out by a child restraint fitting station or licenced motor mechanic.

For vehicles other than Sedans - In Australia, consult your nearest child restraint fitting station or traffic authority for vehicle inspection to find the best, correct position for the placement of the upper anchorage point, and for the correct attachment bolt length and use of spacers. In New Zealand, consult the agent for the vehicle. Note to Queensland purchasers: The installation of anchorage points must be approved by authorised officers appointed by Queensland Transport. Authorised officers can be sourced from all Queensland Transport Customer Service and Kidsafe Queensland.

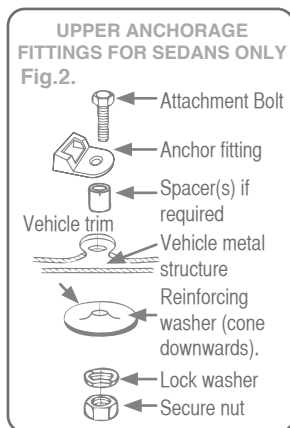

INSTALLATION OF CAR'S UPPER ANCHORAGE POINT

ONLY USE A 5/16 UNC GRADE 5 BOLT. IF THE BOLT IS NOT THE CORRECT LENGTH THE CAR MANUFACTURER'S HAND BOOK CAN PROVIDE ADVICE ON THE CORRECT LENGTH BOLT.



NOTE: Marking on the top of a Grade 5 Bolt. Do not use any bolt without these marks.



WARNING

CHILD RESTRAINTS MUST NOT BE ATTACHED TO UNSOUND METAL OR TO WOOD, OR SYNTHETIC STRUCTURES. WHEN DRILLING 9 MM HOLE DO NOT DRILL THROUGH FUEL LINES, FUEL TANKS, ELECTRICAL WIRING, OR RADIO SPEAKERS. WEBBING STRAPS MUST BE PROTECTED FROM SHARP CORNERS AND EDGES. THE ANCHOR FITTING MUST BE USED ONLY AS DESCRIBED ABOVE. IT MUST NOT BE HOOKED ONTO ANY OTHER OBJECT.

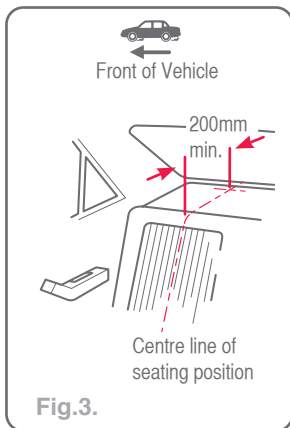

Fig.3.

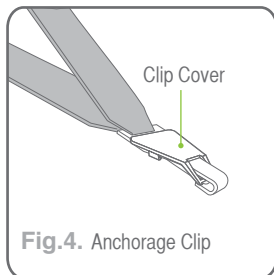

Fig.4. Anchorage Clip

INSTALLATION OF CAR'S UPPER ANCHORAGE POINT

UPPER ANCHORAGE STRAP

The restraint strap & Attachment Clip may be damaged or disconnected by unsecured vehicle contents. To ensure a secure engagement, before each use of the restraint follow this procedure:

- A.** Secure or remove any vehicle contents.
- B.** Remove slack from the Upper Anchorage Strap and ensure that strap is not twisted. The strap does not need to be tight as it may lift the seatbelt off the child's thighs.
- C.** Make sure the Attachment Clip is correctly engaged.

CAR INSTALLATION ACCESSORIES

(From retailers of Britax Safe-n-Sound products)

EXTRA ANCHOR KITS: Available for using the restraint in additional cars.

Re-order no: 0038

TOP TETHER EXTENSION STRAPS: May be required for cars without a fixed parcel shelf.

Re-order no: 0035 (length 300mm) or
0036 (length 600mm)

GATED 3-BAR SLIDE: For converting lap-sash seatbelt to lap belt Re-order number: 0215 (one gated slide is provided with this Harness).

ACCESSORIES & MAINTENANCE

ACCESSORIES

Use of aftermarket accessories (i.e. items not provided in the box with the child restraint), can reduce the safety provided by the child restraint and may cause injury or death.

If applicable, follow the instructions covering the use of accessories provided with this child restraint or spare parts provided by the manufacturer for the restraint.

If an aftermarket accessory is to be used then the manufacturer may advise that it is compliant with AS/NZS 8005 and is stated as suitable for this child restraint

MAINTENANCE

Check the restraint from time to time to ensure that harness is in good condition, mouldings are not cracked or broken.

Ensure all stitching and webbing are not frayed.

Discontinue use if the webbing has frayed or is cut.

Check the adjuster is operating correctly and locking onto the webbing strap.

Discontinue use if an adjuster is not operational or any plastic moulding are cracked or broken.

Clean webbing with damp cloth and allow to dry.

NOTES

IN CASE OF ACCIDENT

If your restraint has been involved in a severe crash, you should destroy the restraint even if no damage is obvious. Some insurance companies offer vehicle insurance which covers or partially covers the replacement of your child restraint. Contact your insurance company for further details. Your insurance company may require you to keep the child restraint for assessment, **but do not use the child restraint after a severe crash.** To assist you in making an accident insurance claim cut the following statement and include it with your claim.

NOTICE TO INSURANCE COMPANY CHILD RESTRAINT INVOLVED IN AN ACCIDENT

This Britax Safe-n-Sound child restraint is manufactured to Australian/New Zealand Standard AS/NZS1754-2013 which requires us to advise users of child restraints to "Destroy the entire restraint if it has been in use in a severe crash, even if no damage is obvious". The joint Australian/New Zealand Standards committee CS/085 advise that this statement applies whether a child was in the child restraint or not. A severe crash, we consider as being one where the main body structure of the vehicle is distorted.

There is no method of determining if the restraint has been damaged and we concur with the Australian/New Zealand Standards in recommending destruction of the child restraint.

This notice is to advise you of the requirements of the Australian/New Zealand Standards and our obligation in complying with the standards.

Please assist the owner of this restraint in their claim.

AUSTRALIA

Britax Childcare Pty. Ltd.

A.B.N 55 006 773 600

Head office and registered address

99 Derby Road, Sunshine, Victoria 3020.

PO Box 147 Sunshine, Victoria 3020.

Customer Service 1300 303 330

Email au-custserv@britax.com

www.britax.com.au

NEW ZEALAND

Britax Childcare (NZ) Ltd.

Customer Service 0508 688 822

Email nz-custserv@britax.com

www.britax.co.nz



CONTACT DETAILS

AUSTRALIA

Britax Childcare Pty. Ltd.
A.B.N 55 006 773 600

Head office and registered address

99 Derby Road, Sunshine, Victoria 3020.
PO Box 147 Sunshine, Victoria 3020.

Customer Service 1300 303 330

Email au-custserv@britax.com

www.britax.com.au

NEW ZEALAND

Britax Childcare (NZ) Ltd.

Customer Service 0508 688 822

Email nz-custserv@britax.com

www.britax.co.nz

INTERNATIONAL ENQUIRIES

Contact your local Distributor.

The Safe-n-Sound, SLIDEGUARD and **VERSATETHER** trademarks are the property of Britax Childcare Pty. Ltd. (Australia).

The Britax Safe-n-Sound trademark is the property of Britax Childcare Holdings Ltd, UK.

We reserve the right to alter this product without notice.

© 2005-2015 Britax Childcare Pty. Ltd.

This product is covered by Australian and overseas Patent applications. Patents pending.

britax
safe·n·sound
CHILD HARNESS
FOR BOOSTER SEATS

Series No. 220/2013

The Child Harness can be used with all Booster Seats or Convertible Booster Seats which nominate that they are suitable for use with this Series 220/2013 Child Harness and are fitted with a **VERSATETHER™** connection.

TO BE USED WITH A LAP-SASH OR LAP ONLY SEATBELT IN THE BACK OF MOST CARS WITH FORWARD-FACING SEATS.

ONLY USE WITH A COMPATIBLE BOOSTER SEAT.

Regional Road Rules may prohibit the use of this restraint in the front seat until the child is 4 years of age. Check your regional rules exemptions.

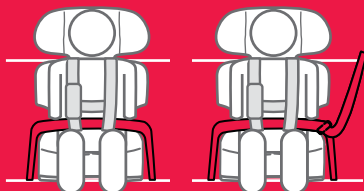

Lap Only belt

Lap/Sash belt

THIS RESTRAINT IS NOT SUITABLE FOR USE WHERE THE TOP TETHER STRAP MAY FALL INTO A SPLIT IN THE SEAT BACK OR OFF THE SIDE OF THE SEAT.

THIS RESTRAINT MUST BE ATTACHED TO A CHILD RESTRAINT ANCHORAGE POINT IN THE CAR. REFER TO CAR OWNER'S HANDBOOK FOR LOCATION OF ANCHORAGE POINTS. REFER TO A CHILD RESTRAINT FITTING STATION IF NO ANCHORAGE POINTS ARE IN THE MOTOR CAR.

No child restraint can guarantee absolute protection from injury in every crash. However, to ensure that your child gets all the protection provided by the Child Harness and the booster seat please read and follow the enclosed instructions exactly.

An Extension strap is provided with the Child Harness but additional Extension Straps may be required for vehicles without a fixed parcel shelf and can be purchased at most child restraint retailers.

Re-order Numbers: 0035 (length 300 mm) or 0036 (length 600 mm)

Spacers, if required, they are included in this package.

This package does not include an adult seatbelt.

P/No. 2202271/B