

*Steelcraft*TM

INFANT CARRIER

Series No. 60/A/2010



FOR BABIES UP TO APPROXIMATELY 6 MONTHS OR WHO HAVE NOT YET REACHED THE SHOULDER HEIGHT MARKER. THIS INFANT RESTRAINT MUST BE INSTALLED SO THAT THE BABY IS REARWARD-FACING AT ALL TIMES.



IMPORTANT:
**KEEP THIS BOOKLET IN THE PLACE PROVIDED ON
THE CHILD RESTRAINT.**

*Steelcraft*TM

www.britax.com.au

Page

- 3.** INTRODUCTION
- 4.** WARNINGS
- 6.** SHOULDER HEIGHT MARKERS & A GROWING CHILD
- 8.** THE NEXT STEP
- 9.** FEATURES
- 11.** SUITABLE FOR USE
- 13.** HOW TO SET-UP
- 20.** HOW TO INSTALL
- 25.** HOW TO USE
- 33.** CARE AND MAINTENANCE
- 38.** ACCESSORIES
- 40.** TRAVELLING TIPS
- 42.** TRAVEL SYSTEM - USE WITH A STROLLER
- 46.** INSTALLATION OF CAR ANCHOR FITTING
- 51.** INSTALLATION ACCESSORIES
- 52.** ALTERNATIVE INSTALLATION IF SEATBELT LOOSENS
- 54.** CARE AND MAINTENANCE
- 56.** CONTACT DETAILS

To be used only in a rearward-facing position for an infant until their shoulders reach the shoulder height marker (approximately 6 months of age).

Continue to use this infant restraint until the child reaches this limit.

Infants are at risk of serious injury if they face forward too early.

TO BE USED WITH A LAP-SASH OR LAP-ONLY SEATBELT IN THE BACK OF MOST CARS WITH FORWARD FACING SEATS.

THIS RESTRAINT IS NOT SUITABLE FOR USE WHERE THE UPPER ANCHORAGE STRAP MAY FALL INTO A SPLIT IN THE SEAT BACK. (E.G. HATCHBACK OR WAGON).

CAREFULLY READ ALL THE INSTRUCTIONS FOR INSTALLATION. IN THE EVENT OF DOUBT ABOUT THE METHOD OF INSTALLATION, CONSULT BRITAX CHILDCARE OR AGENT OR A CHILD RESTRAINT FITTING STATION AUTHORISED BY A RELEVANT TRANSPORT AUTHORITY OR, IN NEW ZEALAND, THE AGENT FOR THE CAR.

No child restraint can guarantee absolute protection from injury in every crash. However, to ensure that your child gets all the protection designed into the restraint, PLEASE READ AND FOLLOW THESE INSTRUCTIONS EXACTLY and use only Safe-n-Sound or Steelcraft (Britax) recommended parts and accessories.

THIS RESTRAINT MUST BE ATTACHED TO A CHILD RESTRAINT ANCHORAGE POINT IN THE CAR. REFER TO CAR OWNER'S HANDBOOK FOR LOCATION OF ANCHORAGE POINTS. REFER TO A CHILD RESTRAINT FITTING STATION IF NO ANCHORAGE POINTS ARE IN THE MOTOR CAR.

Britax Childcare Pty. Ltd. continues to provide care for your children when travelling in motor cars with a range of child restraints suitable throughout their childhood.

This instruction book can be stored under the Infant Carrier for future reference.



WARNINGS

- Use the restraint exactly as shown in the instructions.
- Fit the restraint firmly to the car seat.
- Fit the harness firmly to the child.
- A loose restraint or harness is dangerous.
- **DO NOT LEAVE CHILDREN UNATTENDED IN THE CAR.**
- Supervision of children is needed because they may be able to undo buckles.
- **DO NOT USE A REAR-FACING CHILD RESTRAINT WHERE AN AIRBAG IS FITTED IN FRONT OF THE SEATING POSITION.** For other airbags, refer to the car owner's handbook for warnings and instructions.
- To ensure baby's back is evenly supported do not put more than one nappy on the baby and make sure the nappy is not thickly folded at the back.
- Do not alter or modify this restraint.
- Repairs must only be done by the manufacturer or agent.
- Do not allow the restraint to come into contact with polishes, oils, bleach and other chemicals.
- Destroy the restraint if it has been in a severe crash, even if no damage is visible.
- **DO NOT USE THIS RESTRAINT WITHOUT THE COVER.**
- Make sure the handle is latched properly every time you pick up the Infant Carrier.
- The restraint is not intended to be a substitute baby cot or bed. It is only designed to enable safe transportation of children in motor vehicles. Do not leave a baby in the restraint for long periods of time.



WARNINGS

- Straps may be damaged by unsecured cargo in a collision. Secure or remove hazardous cargo before using this strap. Hatch-back or wagon: Do not use the child restraint where this strap may fall into a split in the seat back.
- Regularly check the restraint components, straps and other fitments for correct function & condition. Seek prompt repair.
- Protect all webbing from abrasion and cutting by sharp corners and edges.
- Upper Anchorage Straps and extension straps may be damaged by unsecured cargo in a collision. Secure or remove hazardous cargo before using this restraint.
- The restraint should not be purchased or sold as a second hand item. It is recommended not to use child restraints older than 10 years as the protection in an accident may be reduced.
- Do not store in areas that may get hot, like in car boots, roof space, beside shed walls which get hot in summer. Do not place heavy items on top of the seat as this may distort the plastic.



WARNING:

DO NOT LEAVE CHILDREN UNATTENDED IN THE CAR.

SHOULDER HEIGHT MARKERS & A GROWING CHILD

NEW BORN

Maximum shoulder height marker

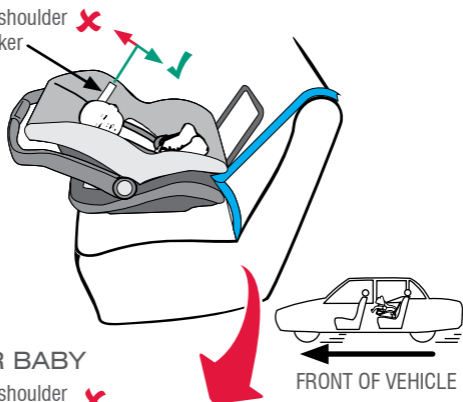

OLDER BABY

Maximum shoulder height marker

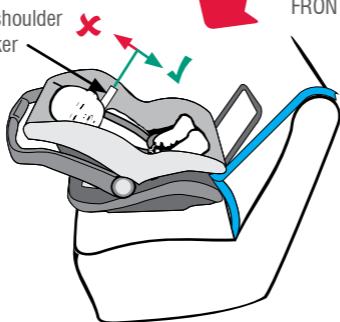

The Infant Carrier is not suitable for your child when their shoulders are above the shoulder height marker.

If the baby's neck muscles are unable to support their head, then the child should remain rear-facing. Choose a child restraint that will take larger babies in rear-facing.

DO NOT MOVE TO THE NEXT RESTRAINT UNTIL THE CHILD'S SHOULDER REACHES THE SHOULDER HEIGHT MARKER.

 **IMPORTANT: Follow this advice.**

MAXIMUM SHOULDER HEIGHT MARKER

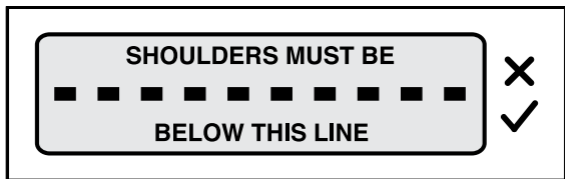

DO NOT MOVE TO THE NEXT RESTRAINT UNTIL THE CHILD'S SHOULDER REACHES THE SHOULDER HEIGHT MARKER.

When the child's shoulder reaches this marker, the child is now too big for the child restraint. It is now time to move to the next child restraint. See next page.

THE NEXT STEP

Choose from:

- Convertible Child Seat, If the convertible seat is suitable for approximately 12 months then continue to keep your child rear-facing until their shoulders reach the lowest marker. Then turn to forward-facing until the child reaches the upper shoulder height marker - approximately 4 years of age.

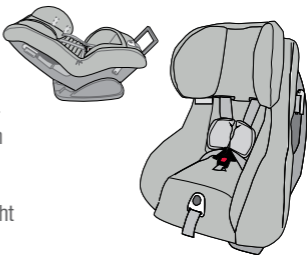

OR

- Dedicated forward-facing seat with in-built harness for children who have outgrown their baby carrier up to approximately 4 years of age.

Forward-Facing
Seat



OR

- Convertible Booster seat with in-built harness that faces forward for children who have outgrown their rear-facing seat. This can be used up to approximately 4 years of age which can then be converted to a booster seat up to approximately 6 to 8 years of age.

Convertible
Booster Seat

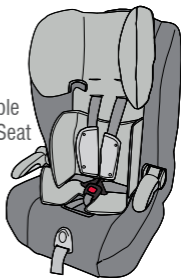

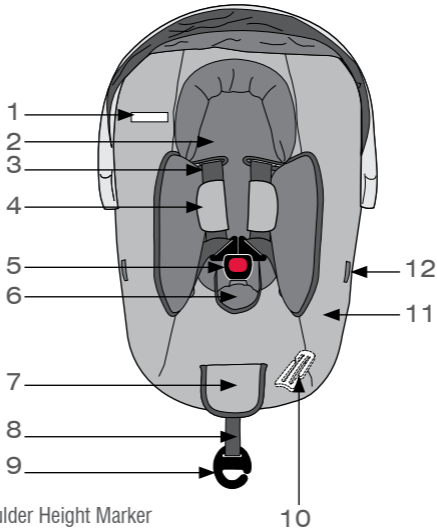

1. Shoulder Height Marker
2. Baby Insert Pad (if fitted)
3. Harness
4. Shoulder Pad (if fitted)
5. Harness Buckle
6. Buckle Pad (if fitted)
7. Harness Adjuster (under flap)
8. Harness Adjustment Strap
9. Harness Adjustment Strap Hook (disconnected)
10. 3 Bar Gated Slide (underneath the carrier)
11. Cover
12. Buckle Tongue Holders (one each side) (if fitted)

FEATURES

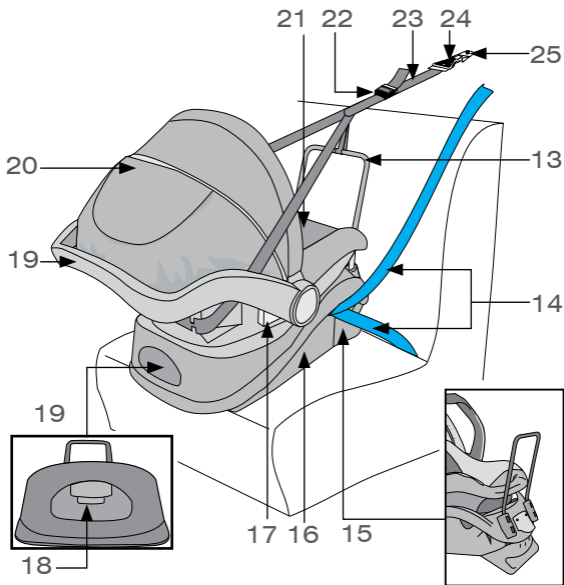

- 13. Stabilising Bar
- 14. Car's Seat Belt
- 15. Angle Adjustment Foot
- 16. Base
- 17. Carry Handle Release Button
- 18. Catch Release Button
- 19. Base Release Catch
- 20. Carry Handle
- 21. Canopy
- 22. Infant Carrier
- 23. Upper Anchorage Strap Adjuster
- 24. Upper Anchorage Strap
- 25. Attachment Clip
- 26. Car's Anchor Fitting

TO BE USED WITH A LAP-SASH OR LAP ONLY SEAT BELT IN THE BACK OF MOST CARS WITH FORWARD-FACING SEATS.

To be used in a rearward-facing position until the infant's shoulder's reach the shoulder height marker (approximately 6 months of age).

Continue to use this infant restraint until child reaches this limit.

Infants are at risk of serious injury if they face forward too early.

If the baby's neck muscles are unable to support their head, then the child should remain rear-facing in a restraint that is larger, possibly a Convertible child restraint.

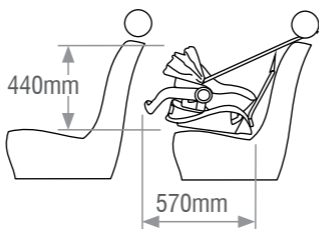

Seat Width 430mm

To ensure that the space is sufficient, the purchaser should check the measurements between the vehicle's rear and front seats in which the child restraint is intended to be used.

WARNINGS

THE UPPER ANCHORAGE STRAP MUST ALWAYS BE FITTED WHEN THE CHILD RESTRAINT IS USED IN A VEHICLE.

Do not use the restraint without the Upper Anchorage Strap correctly attached.

The upper anchorage strap must be attached to an anchorage point using an extension strap if necessary.

The Baby Carrier can just touch the front seat, but must not in such a way that the installation angle is affected.

Do not recline the seat excessively, it must be installed at the correct angle (see page 21).

Do not allow the front seat to alter the installed position of the restraint, It is permissible to allow the restraint to touch the seat on front of it.

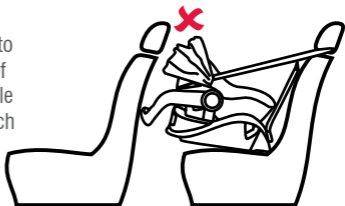

Regional Road Rules may restrict the use of child restraints like this Infant Carrier in the front seat of the car. Check your local Road Rules.

Do not use on any car seat which faces sideways or rearwards.

DO NOT USE A REAR-FACING CHILD RESTRAINT IN A SEATING POSITION WHERE AN AIRBAG IS FITTED. For other airbags, refer to the car owner's handbook for warnings and instructions.

Seat belt extenders should not be used if the seat belt is not long enough to fit around the child restraint base.

REMOVING INFANT CARRIER FROM BASE

- A. Squeeze the Release handle button (on both sides) and rotate the handle to upright carry position until the indicator is green.

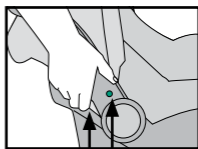

Release handle button Red/Green Indicator

- B. Grasp the carry handle with one hand, then squeeze the base catch release button and pull out base release catch with the other hand. With the catch released, raise the Infant Carrier away from the base.

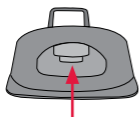

Squeeze catch release button

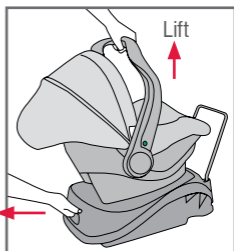

Then pull base release catch

ADJUSTMENT OF HANDLE POSITION

A. The Infant Carrier features a sturdy carry handle. At the base of the handle there are handle release buttons on each side which control the three positions of the handle. The carry position is upright and suitable to carry the baby. Ensure the indicator at the side of the handle is green, which will indicate the handle is locked, and it is safe to lift the Carrier. If the indicator is red then it is not locked and unsafe to lift the baby.

Carry Position

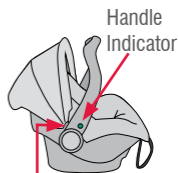

Handle release button

B. To convert from carry to access position, press the handle release button on each side and rotate the handle towards the front of the Infant Carrier. Rotate until the handle locks into the next position. The handle indicator will turn from Red (unlocked) to Green when the handle is locked.

Access Position

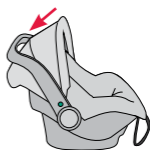

This position ensures the handle does not interfere with the attachment of the upper anchorage strap or removal of the baby.

C. To convert to a non-rocking position press both handle release buttons and rotate the handle to the next position. Ensure the handle is locked in position securely. The handle can also be in any position when the infant carrier is installed in the car.

Non-rocking Position

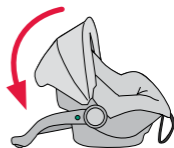

D. Press the handle release buttons to reposition the handle to suit your needs.



IMPORTANT:

Make sure the handle is engaged properly and the handle indicator is Green every time you pick up the Infant Carrier.

TO REMOVE/FIT CANOPY

- To remove the Canopy, unclip the elastic Canopy loops from the cover strap clips at the handle pivot point.
- Then pull the plastic canopy frame out of the mouldings at both sides of the infant carrier.
- Fitting the Canopy is the reverse of the removal procedure.

Elastic Canopy loops must always be fitted when Canopy is in use.

- The Canopy can be rotated to cover the baby or opened by rotating to the desired position.

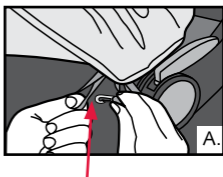

Elastic Canopy loops

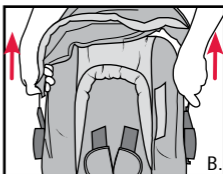

SETTING UP THE HARNESS

- Sit the Infant Carrier on a flat ground with the handle rotated fully back to prevent rocking.
- Release the buckle and lengthen the Harness Straps by pressing Harness Adjuster (under the flap) while grasping both Shoulder Harness Straps and pulling out desired amount of slack.



Lift the Harness Adjuster up and pull the Harness Straps to slacken.

HOW TO SET-UP

- C. Move the two harness tongues to the sides of the infant carrier and store in the Buckle Tongue Holders (if fitted) (holders are on both sides of the cover). Move the harness buckle towards the Harness Adjuster.

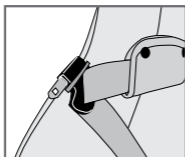

Buckle Tongue Holder (if fitted)



- D. Place baby into Infant Carrier lying on its back so that the buckle is between the baby's legs.



Correct fitment of the harness is very important as it restrains the baby in the Infant Carrier. The harness must fit firmly around upper torso of the baby and be positioned so as to leave the baby's arms and legs free.

This Infant Carrier needs to be used until the baby reaches the shoulder height marker. It is acceptable for the legs to be bent to fit.

E. The Infant Carrier is fitted with three shoulder strap positions. As the baby grows, the shoulder straps must be moved to higher slots.

The shoulder straps must be in the slots which are nearest to the child's shoulders, but not lower than the child's shoulders.

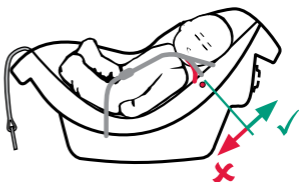

1. Upper shoulder strap slots
2. Medium shoulder strap slots
3. Lower shoulder strap slots
4. Shoulder harness strap
5. Harness tongues & buckle
6. Lap strap slot
7. Crotch strap slot
8. Maximum Shoulder Height Marker
9. Harness Adjuster (under cover flap)
10. Adjuster Strap

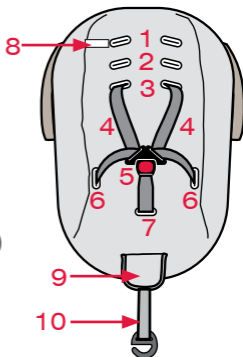

If the baby is new born you will need to use either slot 2 or 3. With the baby in the carrier, check that the slot is just above the baby's shoulder. If the strap is not in that slot then change the slot as described on the next page. If the slot is just above the shoulders then go to page 20.

HOW TO SET-UP

- F. At the rear of the Infant Carrier, remove one of the harness shoulder straps from metal Strap Connector by slipping strap through open slot. The Metal Strap Connector is shown in diagram right.

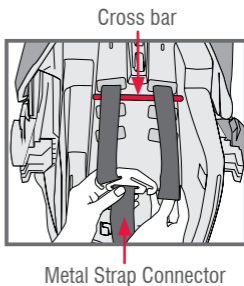

- G. Pull the shoulder strap through slot.
H. Insert the shoulder strap through the Infant Carrier slot which will position the shoulder strap level with or above the baby's shoulder (see page 17). Ensure that the shoulder strap passes through matching slots in the cover and seat shell.

If a Padded Insert is used then that will need to be re-positioned and the strap re-inserted when changing the slot position.

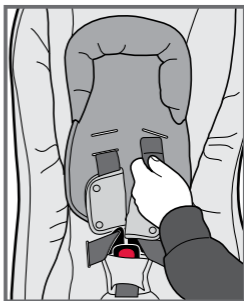

- I. Ensure there are no twists in the straps.
- J. Thread the shoulder strap over the bar and connect it to the Metal Strap Connector at rear of Infant Carrier.
- K. Repeat for the other shoulder strap. It is better to change one strap at a time so that the other strap will be a guide for re-assembly.

NOTE: Both straps must be over the cross bar to ensure that the straps will tighten fully on the baby.

FOR SMALL BABY

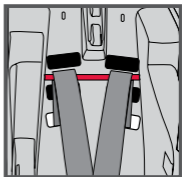

FOR GROWING BABY

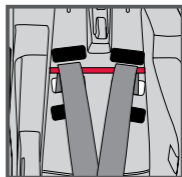

FOR LARGER BABY

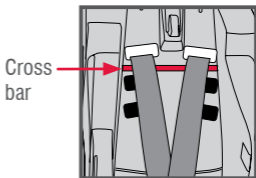

IMPORTANT:

Do not use the carrier with the harness shoulder straps set at different heights or fed through mismatching slots. Ensure the harness straps are not twisted and that all straps are secured by pulling each harness strap.

HOW TO INSTALL

Consult the car owner's handbook for location of anchor fittings or anchorage points. Some vehicle manufacturers recently have an anchor fitting fitted in the car.

If there is no child restraint anchor fitting or child restraint anchor point refer to page 49 for the installation of the anchor fitting as well as the use of extension straps.

An anchor fitting is required to attach the upper anchorage strap to fully install the Carrier to the car. The upper anchorage strap must be used with this infant carrier when used in the car.

For installing the Base to the car, select a seating position with a child restraint anchor fitting directly behind the seating position.

INSTALLING THE BASE TO THE CAR

- A. Place the base and Infant Carrier on vehicle seat in a seating position where a child restraint anchor fitting is installed. The Level Indicator Line needs to be level with the road, (ie parallel with the road surface). Check and adjust the recline angle of the base if necessary.

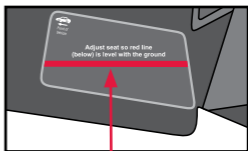

Level Indicator Line on both sides of base.

- B. If your car's seat is contoured then you may need to adjust the angle of the base so your baby is not too upright.

The recline angle may be altered using the three position adjustment foot located at the stabilising bar end of the base. To adjust, pull out on angle adjustment foot adjuster and lower or raise the angle adjustment foot to the desired position. Place back in the seating position and check the Level Indicator Line.

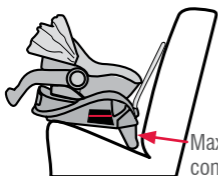
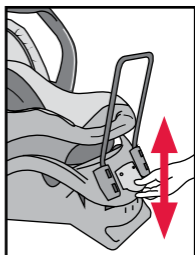

Road

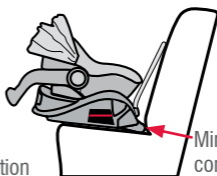

Road

HOW TO INSTALL

- C. For car's with flat seats, some packing (such as firmly rolled up nappy or towel) may be required to get a better angle and to have the stabilising bar contact the car's seat back or close to the seat.

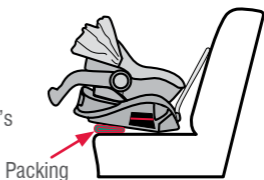

- D. Place the base into the car in the selected seating position with the Stabilising bar beside the car's seat back as shown.

Feed the Belt through the guide hooks

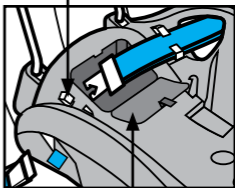

- E. Open the belt cover. Extend the seat belt to maximum length. For a lap-sash seat belt, position the tongue in the middle of the fully extended belt. Feed the seat belt through the opening and the guides on each side of the base, following the blue REAR-FACING SEATBELT PATH labels on each side.

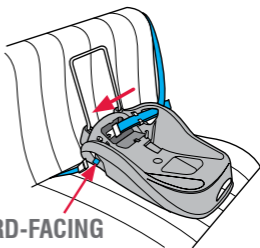

- F. Engage the seat belt tongue to the buckle.
- G. Pull the slack out of the seat belt and ensure the base is held firm against the seat back. If a lap-sash seat belt is used then allow the excess sash belt to feed back in to the retractor. Then close the Belt cover.

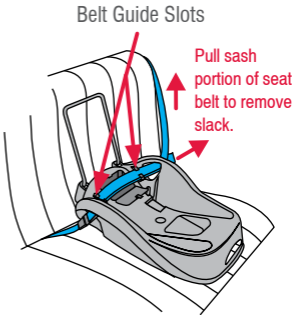

Close belt cover

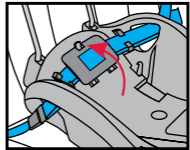

NOTE: If seatbelt loosens refer to page 52 for use of alternative Gated 3-Bar Slide.

To remove the base from the car, release the seat belt, lift the belt cover and pull the seat belt out.

INSTALLING UPPER ANCHORAGE STRAP

A. Locate the child restraint anchor fitting in the car that is directly behind the seat location in the rear seat you have chosen. Refer to the car owner's manual for the location (If there is no anchorage fitting then refer to page 49 for instructions in adding an anchor fitting.) Connect the Upper Anchorage Strap Attachment Clip to the Anchor Fitting.

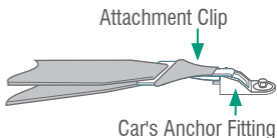

Lengthen the strap by pressing the adjuster button (1) and pull the strap (2) so that the strap is ready to attach to the Carrier.

Fully press Adjuster Button (1) while pulling Upper Anchorage Strap (2) to lengthen.

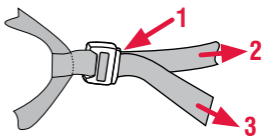

THIS UPPER ANCHORAGE STRAP MUST ALWAYS BE FITTED WHEN THE INFANT CARRIER IS USED IN THE CAR.

B. While the Infant Carrier is out of the car, store the upper anchorage strap between the stabilising bar and the car seat back so that it will be ready for use when the Infant Carrier is put back in the car.



WARNING

Always attach hook and remove slack.

C. If the seat belt will not stay tight, then fit the 3-bar gated buckle to the lap-sash belt to prevent loosening. See pages 52 to 53.

PLACING BABY IN INFANT CARRIER

When positioning baby into Infant Carrier make sure baby's back is fully supported onto the flat section and the baby's nappy area (bottom) is resting in the bottom curvature as shown. It is recommended that bulky nappies are not used when baby is travelling in the Infant Carrier as they can cause incorrect positioning of the baby's back in the Infant Carrier.

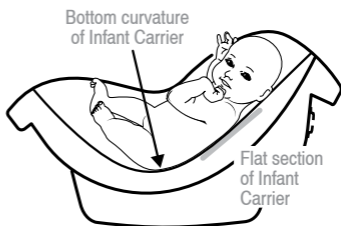

HOW TO USE

- A. Loosen Harness Straps by pressing the Harness Adjuster while grasping both the Shoulder Harness Straps and pulling out the desired amount of slack.

Press the Harness Adjuster and pull Harness Straps to loosen.

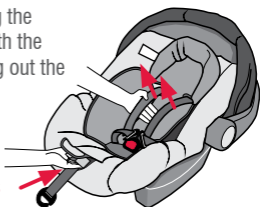

- B. Move the two harness tongues to the outer extents of the infant carrier, into the Buckle Tongue Holders (if fitted). Move the harness buckle towards the Harness Adjuster.

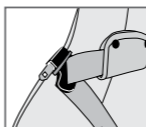

Buckle Tongue Holder (if fitted)

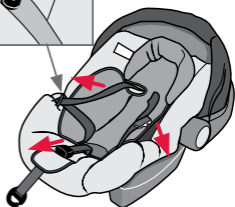

- C. Place baby into Infant Carrier lying on its back so that the buckle is between the baby's legs. Ensure that baby's arms and legs are free. Make sure baby is dressed to allow the Harness Buckle to be pulled up between baby's legs e.g. a jump suit. **Never wrap the baby in a blanket before placing in the Infant Carrier.**



NOTE: Discontinue using the Padded Insert if the Pad cause over heating, discomfort or you need more room for the child to grow.

SECURING BABY IN INFANT CARRIER

A. Place each arm through each shoulder strap of the harness. Position the buckle of the crotch strap as shown right.



B. Fit either harness tongue into the Harness buckle followed by the other tongue until a click is heard. If the second tongue does not engage - press the red button and re-insert the tongues. Check secure engagement by pulling harness straps.

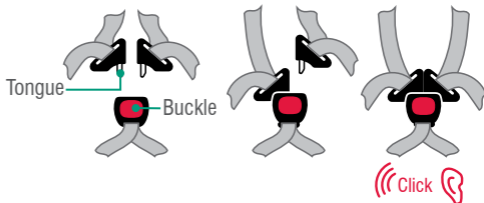

⚠ CAUTION:

The end of the harness adjustment strap is connected to the cover to avoid tripping over the end. Ensure the harness adjustment strap hook is attached when carrying the carrier (see page 28).



HOW TO USE

C. Ensure slack is removed from the lap straps by pulling the shoulder harness straps through the buckle tongues, then pull the Harness Adjustment Strap to take up the slack in the harness, adjusting to a firm but comfortable fit. Make sure that the baby's arms and legs are free and the crotch strap is between the legs. Check that the slack in straps is minimal.

Do not use the restraint if straps do not tighten and contact your local authorised service agent for repair.

Pull Harness Straps through the buckle in direction of arrows

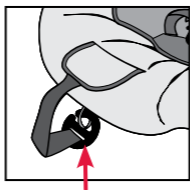

Hook Adjuster Strap on to the loop to prevent tripping over the strap.

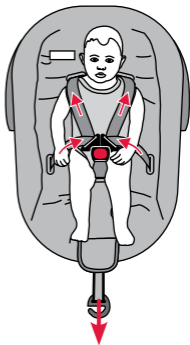

Pull Harness Adjustment Strap to remove slack.



IMPORTANT:

Do not place the Baby Carrier on a table or a work-top, where it could fall off or be knocked on to the floor.



CAUTION: A LOOSE HARNESS IS DANGEROUS

The end of the harness is connected to the cover to avoid tripping on the end. Ensure the Harness adjustment strap hook is attached when carrying the carrier (see above).

PLACING BABY & INFANT CARRIER IN BASE

A. Position the Infant Carrier over the top of the base. Make sure the Harness Adjustment Strap is not caught between Infant Carrier and Base then lower the Infant Carrier into position.

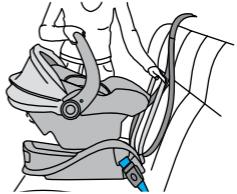

B. Push down on the Infant Carrier until an audible click is heard. Pull on the Infant Carrier to ensure it is correctly locked into position.

! IMPORTANT:
Lift again to check engagement.

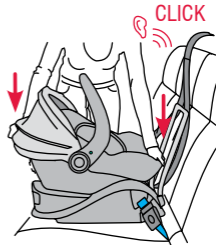

C. The handle may be rotated into other positions if needed.

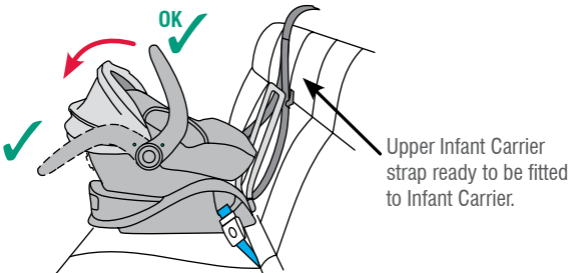

HOW TO USE

- D. Engage the upper anchorage strap attachment clip to the car's anchor fitting, if not already connected.

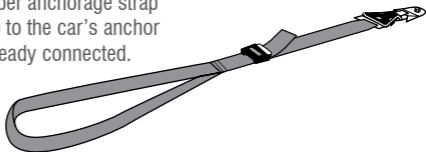

- E. Feed the Upper Infant Carrier strap on the inside of the handle and through the locating slots in the front of the Infant Carrier.

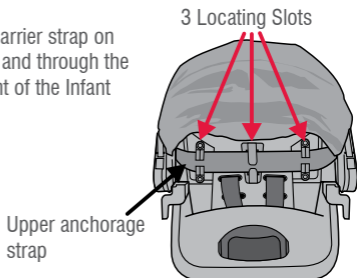

- F. Adjust the Upper Anchorage Strap by pulling as shown below to remove any slack in the straps. Do not over tighten.

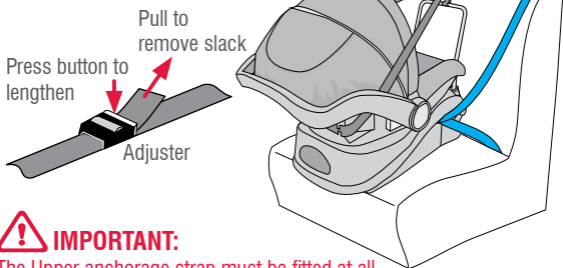

IMPORTANT:

The Upper anchorage strap must be fitted at all times when the baby is in the car.

REMOVING BABY & INFANT CARRIER FROM BASE

- Loosen the upper anchorage strap by fully pressing the adjuster button while pulling the upper anchorage strap. Ensure that the adjuster does not fall on the baby.
- Remove the upper anchorage strap from the locating slots in the Infant Carrier. Store the upper anchorage strap behind the stabilising bar.
- Rotate the Carry Handle to the “carry” position and ensure it is locked correctly before lifting.
- Grasp the carry handle with one hand, then squeeze the base catch release button and pull out base release catch with the other hand. With the catch released, raise the Infant Carrier away from the base, you may need two hands to lift the carrier out of the car. Place feet apart and use bent legs to lift the carrier to avoid back injury.



Squeeze catch release button

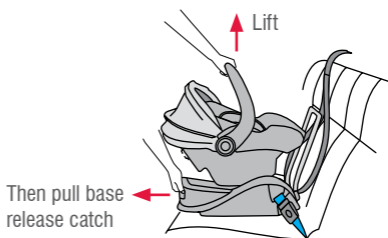

- When the Infant Carrier is clear of the base, carefully remove it from the car.
- Always keep baby secure in the integral harness when carrying.

Ensure the adjustment strap hook is connected to the cover, see page 28.

HOW TO USE

REMOVAL OF BABY FROM INFANT CARRIER

A. Rotate the carry handle to either the access or non-rocking position and ensure the Canopy is fully open.

B. Press the Harness Adjuster while pulling shoulder straps to loosen the harness.

C. Press the red button on Harness Buckle then both Harness Tongues will be released. Place Buckle tongues through Buckle Tongue Holder's (if fitted) on each side of the cover.

D. Feed the baby's arms through each side of the Harness and place the straps on each side of the carrier clear of the baby. Lift the baby out of the carrier.

NOTE: Once the baby gets heavier you may wish to leave the carrier in the car. In this case you will need to disconnect or loosen the upper anchorage strap before removing the baby.

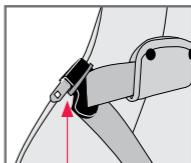

Buckle Tongue Holder
(if fitted)

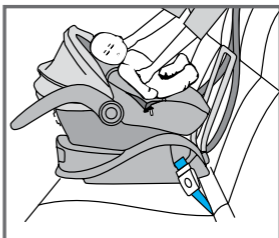
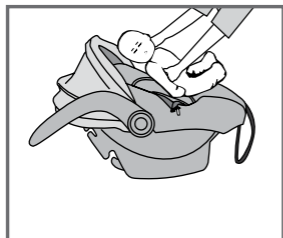

REGULAR CARE OF THIS RESTRAINT:

Please check the following items regularly to ensure the safety of your child:

- A. Check the webbing for fraying.
- B. Ensure the inside of the buckle is free of foreign matter, food or feeding liquids. Check that the buckle clicks and is not sluggish or sticky in operation. If sluggish, wash the buckle as shown on page 38.
- C. Ensure there are no cracks in moulding or the plastic moulding.
- D. Check the harness adjuster is operating and is clamping the webbing.
- E. If any part of the Infant Carrier is cracked or broken, seek repair immediately or replace the Infant Carrier.
- F. Check that the Infant Carrier catch retains the Infant Carrier to the base. Check screws and rivets are firmly in place. If not seek repair.

CLEANING

Use only mild soap and water with a damp cloth to clean all straps, metal and plastic parts of the restraint. Do not use chemicals or cleaning agents.

CARE AND MAINTENANCE

COVER

For baby's comfort and health the Infant Carrier cover is removable for cleaning. Cleaning instructions are on the care label attached to the liner. Washing the cover prior to use will remove excess fluff and dye's.

TO REMOVE THE COVER

- A. Remove the Canopy and Baby insert pad (if supplied) as described on page 15. Unclip the two infant carrier cover straps which are secured by plastic hooks under the handle attachment point.
- B. Disconnect the shoulder harness straps from the Metal Strap Connector and feed through shoulder slots in both infant carrier and cover. Refer to page 18.
- C. Feed the shoulder harness straps and tongues through lap strap slots in the Cover only. There is no need to remove the harness straps from the Infant Carrier.
- D. Lift the cover around the rim of the infant carrier at the harness adjuster end, feed the crotch buckle through the slot in cover and pull the harness adjuster strap out of the slots.
- E. Remove the cover for cleaning.

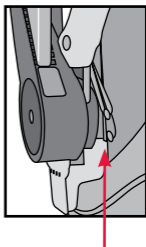

Unhook clips on either side of cover under the handle then remove cover

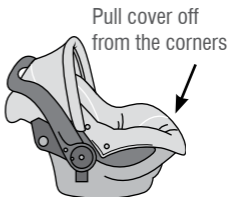

TO REPLACE THE COVER

A. Place the cover over the infant carrier ensuring all slots in cover line up with slots in infant carrier.

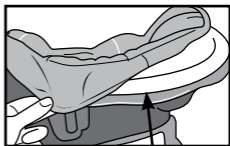

Pull elastic cover over Infant Carrier

B. Ensure that there are no twists in all straps underneath the Infant Carrier.

C. Feed the shoulder harness straps through lap strap slots in cover.

D. Feed the shoulder harness straps through the shoulder strap slots in cover and then in through the Infant Carrier (ensure it is over the cross bar). Refer to page 17 for correct shoulder harness position for your baby. Attach the shoulder harness straps to the strap connector.

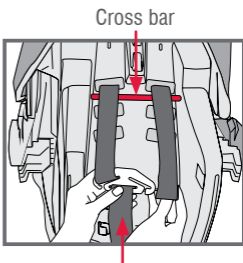

Cross bar

Strap Connector

E. Feed the crotch buckle as well as the harness adjuster strap through the slots in the cover.

F. Refit plastic hooks on cover to Infant Carrier as shown right.

G. Engage shoulder harness tongues and crotch buckle. Pull to check harness is attached.

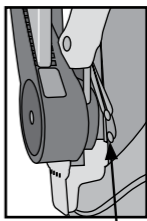

Plastic Hooks

H. Ensure the straps are not twisted.

COVER (style may vary)

The cover has been designed to protect your child when seated in the Infant Carrier. Care should be taken if children either eat or drink while in the Infant Carrier as some products may cause damage or marking to the cover.



IMPORTANT:

Do not pull sticky items from covers as the cover may be damaged - soak in water and gently remove.

The seat cover and accessories must not be replaced with any other than the one recommended by Steelcraft, because the cover is an integral part of the child Infant Carrier and how it performs. The child Infant Carrier must not be used without the cover and the padding provided.



VERY IMPORTANT:

Only use this child restraint with the cover supplied or a manufacturer-authorized replacement cover with identical shoulder height markers.

BUCKLE OPERATION

To ensure the buckle remains operational the inside of the buckle must be kept free of liquids, sand, dirt, fluff, food or similar substances. If the buckle is not operating or does not have the click when second tongue is inserted then the buckle needs to be washed or replaced. Contact our Customer Service Department for assistance.

TO CLEAN HARNESS BUCKLE:

If sticky liquids such as baby formula, fruit juice, etc. get inside your Harness Buckle, it may become sluggish. An indication of a sluggish Harness Buckle is that you cannot hear a click when engaging the Harness Tongues. To restore the Harness Buckle to good working order it needs to be cleaned as follows:

A. Remove the Harness Buckle from the Infant Carrier by disengaging the 3-bar slide.

B. Place the Harness Buckle under warm (approx. 40° Celsius) running water as shown below. Let the water run through the mouth of the buckle for five minutes.

C. Engage and disengage the Harness Tongues and Buckles several times until a strong audible click is heard.

D. Refit the harness buckle to the Infant Carrier with the red button facing out and clip the 3-bar slide into the moulded housing.

E. If you still cannot hear a strong audible click after engaging the Harness Tongues & Buckle, then repeat cleaning several times. If the Harness Buckle cannot be returned to its original working condition then contact Britax Childcare.

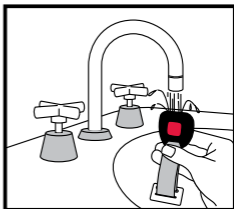
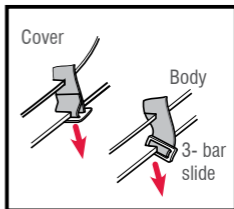

BOOT COVER (where fitted)

A Boot Cover (where fitted) provides shade from the sun and protection from wind whilst the Infant Carrier is installed on the Travel System Stroller.

DO NOT USE the boot cover on the carrier whilst installed in the car as it will prevent the quick release of a baby in a crash.

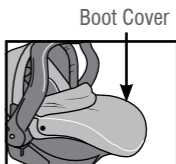

BUCKLE PAD (where fitted)

A. To fit the buckle pad, grasp the loop at the base of the buckle pad and pull over the harness buckle as shown right.

B. To remove, simply slide the buckle pad off the harness buckle.

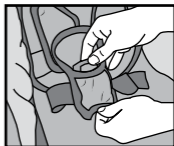

SHOULDER PADS (where fitted)

A. The shoulder pads may require release by press studs. If fully fitted to the shoulder strap then you will need to disconnect the shoulder strap as described on page 18.

EXTRA BASE

There are Steelcraft Extra Bases available as a separate purchase for a second car. These bases can mean that the Carrier can be easily and quickly switched between cars. The Extra Base has the same installation requirements as the Base in these instructions.

OTHER ACCESSORIES

Only use accessories designed for this product and recommended by Britax Childcare Pty Ltd.

SAFETY

Never hold a baby in arms when riding in a motor vehicle. In this position the baby could be thrown against the dashboard, windscreen or other occupant and suffer serious injury or death.

When riding in a motor vehicle never nurse a baby and use the same seat belt for both of you. In this position the baby or child could be crushed.

Children must be secured in appropriate restraints at all times when the car is in motion. Children travelling unrestrained and standing up in the car are in danger of serious injury or death. Traffic regulations in all states require children to be secured in child restraints or adult seat belts where available.

Plan your trip with frequent comfort stops to reduce stress on babies, young children and driver. Keep the car well ventilated to reduce heat stress. Two car windows should be kept open to maintain a good flow of fresh air if air conditioning is not used.

Never leave babies or toddlers in a stationary car in the sun because of the risk of heat exhaustion.

Ensure babies and toddlers are adequately shaded from direct sunlight through side or rear windows.

Be on guard against carbon monoxide poisoning which can occur through only a slight leak in the exhaust system while travelling in a closed car.

Securely stow all heavy objects, feeding bottles, etc. that could become missiles during an accident and cause injury to any occupant.

CLOTHING/BATHING

Take several changes of clothing and bibs for possible car sickness. Disposable nappies and liners are very handy while travelling. Since it is often warmer in the car, dress the baby in light clothing. When cooler, it is easier to place a blanket over the baby than it is to remove the baby from the restraint and change clothes.

Take a pack containing baby soap, oil, powder, cotton wool, small towel and wet washer in a plastic bag.

FEEDING

Never breast feed a baby while car is in motion. Babies will require extra feeding if travelling in the heat. For bottle fed babies, make up the bottles and refrigerate before leaving home for a day trip. Place in a cool bag and reheat as needed with hot water from a thermos.

Alternatively, bring boiled water in a thermos and pre-measured amounts of baby formula in small containers. Use the water from the thermos to mix with the formula when required. Regardless which method is used, it is always a good plan to carry some boiled water in a sterile container or bottle.

Do not attempt to carry warm milk because germs multiply rapidly in warm milk.

TRAVEL SYSTEM-USE WITH STROLLER

This Infant Carrier is designed to be connected to compatible Steelcraft strollers. The following pages provide a general instructions about using the Infant Carrier with a stroller which may differ slightly for some strollers. Preferably use the attachment instructions provided with your stroller. Use the stroller in accordance with the instructions supplied with the stroller.



WARNINGS

DO NOT LEAVE THE CHILD IN THE INFANT CARRIER FOR EXTENDED PERIODS.

THE INFANT CARRIER IS DESIGNED TO PROVIDE MOBILITY OUTSIDE OF THE CAR BUT IT SHOULD NOT BE USED IN PLACE OF AN APPROPRIATE COT.

THE INFANT CARRIER MUST ONLY BE USED WITH A STEELCRAFT STROLLER WITH COMPATIBLE ATTACHMENTS. DO NOT USE WITH ANY OTHER STROLLER.

IF IN DOUBT ABOUT THE METHOD OF INSTALLATION OR SUITABLE COMPATIBLE STROLLERS, CONTACT BRITAX CHILDCARE CUSTOMER SERVICE ON 1300 303 330.

TO INSTALL INFANT CARRIER INTO STROLLER



IMPORTANT:

Only use Infant Carrier with compatible Steelcraft Stroller.

- A. Where applicable, remove the stroller seat or bassinet from the stroller frame (refer to stroller instructions). With the Infant Carrier handle in the carry position, engage the Infant Carrier tongue mouldings on each side directly over the stroller frame mouldings.

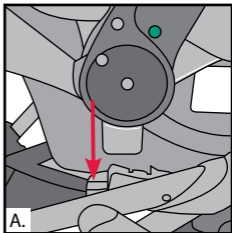

- B. Push down on the Infant Carrier and make sure it is located into the stroller frame mouldings. The Carrier is not yet fixed to the stroller.

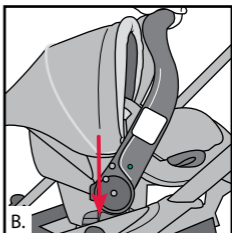

TRAVEL SYSTEM-USE WITH STROLLER

C. By pushing in and holding the release buttons on either side of the handle, rotate the handle backwards to the install position. The GREEN indicator will now turn RED.

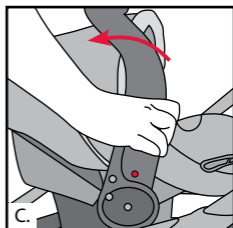

D. Release the handle latches. Then with one hand holding the front of the Infant Carrier, push the Infant Carrier handle all the way down until you hear it lock into the frame.

E. The handle indicator will now be GREEN and the Infant Carrier should be locked into the frame.

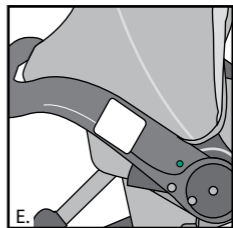

IMPORTANT:

F. Pull up on both sides of the Infant Carrier to confirm it is locked into the frame. If not locked in on both sides, repeat steps A to E.

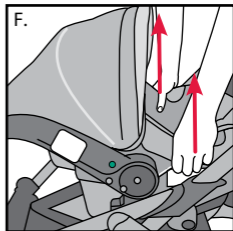

G. If the baby is not already in the Infant Carrier then secure your baby into the Infant Carrier by the harness (see page 27).

VERY IMPORTANT:

Always lock the Infant Carrier to the stroller frame by rotating the handle.

TO RELEASE INFANT CARRIER FROM STROLLER

A. Squeeze both handle latches in to release the locks.

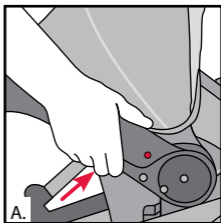

B. Rotate the handle forward, towards the carry position.
The indicator will now be RED.

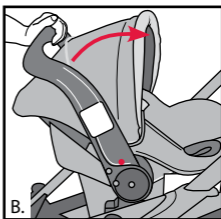

C. Once in the carry position the indicator will be GREEN. Lift and remove the Infant Carrier away from the stroller frame.

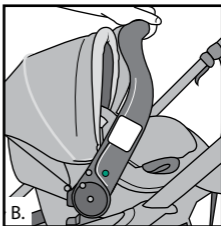

WARNING

Use the harness at all times.

INSTALLATION OF CAR ANCHOR FITTING

Consult the vehicle owner's handbook for location of anchorage fittings or anchorage points and the possible use of spacers. Some vehicles may have an anchor fitting fitted by the vehicle manufacturer.

If your vehicle is not fitted with an anchor point, please contact a Safety Restraint Fitting Station authorised by the relevant State Government Body for correct fitment of the restraint. In New Zealand contact the agent for the vehicle. The upper anchorage strap must be attached to an anchorage point using an extension strap if necessary.

UPPER ANCHORAGE STRAP



IMPORTANT:

THE ATTACHMENT CLIP COVER MUST ALWAYS BE USED AS IT PREVENTS THE RISK OF INCORRECT FITMENT OF THE ATTACHMENT CLIP TO THE ANCHOR FITTING. ALWAYS ENSURE THAT THE ATTACHMENT CLIP IS CORRECTLY ENGAGED TO THE ANCHOR FITTING AND NOT HOOKED OR FITTED TO ANY OTHER OBJECT BEFORE EACH USE OF THE RESTRAINT. THIS IS ESPECIALLY IMPORTANT IN VEHICLES SUCH AS STATION WAGONS, VANS, HATCH BACKS OR VEHICLES WITHOUT A FIXED PARCEL SHELF, SINCE THE ANCHOR POINT IS USUALLY NOT VISIBLE.

INSTALLATION OF CAR ANCHOR FITTING

IMPORTANT INSTALLATION NOTE:

In some vehicles the anchor fitting in the rear vertical panel can only be installed in one way. Please refer to vehicle owner's handbook or a child restraint fitting station for correct method.

Extension Strap distance to be measured.

Length 300mm (Use Safe-n-Sound™ part 0035 or equivalent).

Length 600mm (Use Safe-n-Sound™ part 0036 or equivalent).

Available from all major child restraint retailers.

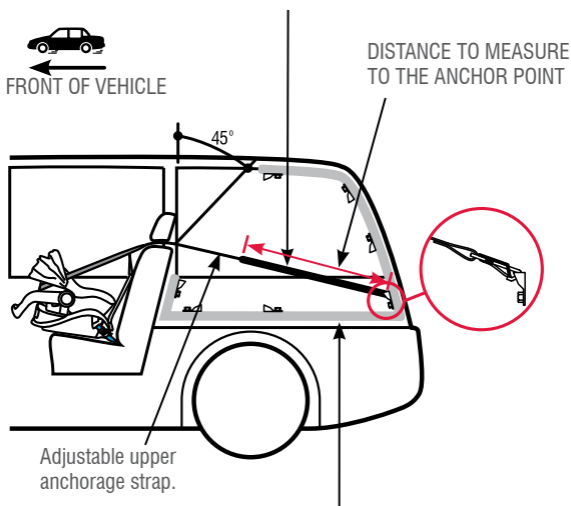

The shaded areas of this diagram illustrate the possible locations of the anchor fitting. Within each shaded area is an anchor fitting showing the correct way to install the fitting. Ensure the anchor fitting is aligned as illustrated unless stated otherwise in the vehicle owner's handbook.

INSTALLATION OF CAR ANCHOR FITTING

IF THE CAR IS FITTED WITH CHILD RESTRAINT ANCHORAGE POINT

Locate the anchorage point behind the rear seating position (consult the car owners handbook for the location of the anchorage point). The anchorage point should be directly behind and central to the restraint. Remove thread plug from the parcel shelf/floor/roof, etc. and install attachment bolt and fitting as shown below.

CAUTION: DO NOT OVERTIGHTEN ATTACHMENT BOLT.

OVERTIGHTENING MAY FRACTURE OR BREAK BOLT. MAXIMUM TORQUE IS 20 Nm (14.75 ft.lb.)

Note: Minimum of five full turns of attachment bolt is required before tightening force is applied.

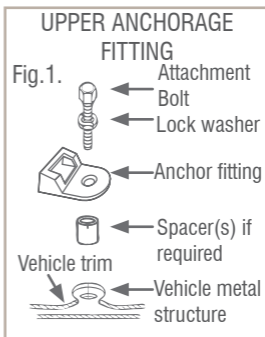

INSTALLATION OF CAR ANCHOR FITTING

IF THE CAR IS NOT FITTED WITH CHILD RESTRAINT ANCHORAGE POINTS

For Sedans only - Drill 9mm diameter hole in the parcel shelf on the centre line of the seating position as shown below. Before drilling the hole, check the underside for accessibility. Install the attachment bolt as shown below.

For vehicles other than Sedans -

In Australia, consult your nearest child restraint fitting station or traffic authority for vehicle inspection to find the best, correct position for the placement of the anchorage point, and for the correct attachment bolt length and use of spacers. In New Zealand, consult the agent for the vehicle.

Note to Queensland purchasers: The installation of anchorage points must be approved by authorised officers appointed by Queensland Transport. Authorised officers can be sourced from all Queensland Transport Customer Service and Queensland Ambulance Service Centres.

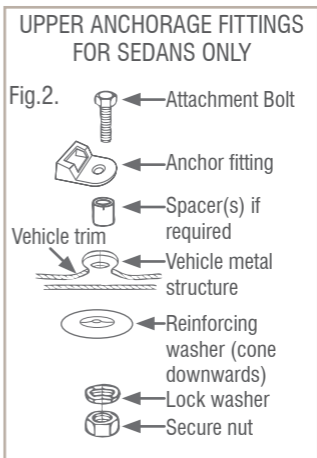

INSTALLATION OF CAR ANCHOR FITTING

ONLY USE A 5/16 UNC GRADE 5 BOLT. IF THE BOLT IS NOT THE CORRECT LENGTH THE CAR MANUFACTURER'S HAND BOOK CAN PROVIDE ADVICE ON THE CORRECT LENGTH BOLT.



Note: Marking on the top of a Grade 5 Bolt.



WARNING

CHILD RESTRAINTS MUST NOT BE ATTACHED TO UNSOUND METAL OR TO WOOD, OR SYNTHETIC STRUCTURES. WHEN DRILLING 9 MM HOLE DO NOT DRILL THROUGH FUEL LINES, FUEL TANKS, ELECTRICAL WIRING, OR RADIO SPEAKERS. WEBBING STRAPS MUST BE PROTECTED FROM SHARP CORNERS AND EDGES. THE ANCHOR FITTING MUST BE USED ONLY AS DESCRIBED ABOVE. IT MUST NOT BE HOOKED ONTO ANY OTHER OBJECT.

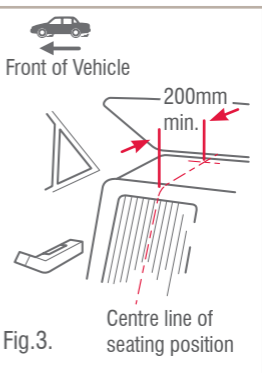

CAR INSTALLATION ACCESSORIES

(From retailers of Safe-n-Sound products)

EXTRA ANCHOR KITS: Available for using the restraint in additional cars - Re-order no: 0038

EXTENSION STRAPS: May be required for cars without a fixed parcel shelf.

Re-order no: 0035 (length 300mm)

0036 (length 600mm)

GATED 3-BAR SLIDE (Locking clip): For converting lap-sash seat belt to lap belt, and to obtain a better fit to the car. Most cars will not need this - Re-order no: 0215.

ALTERNATIVE INSTALLATION IF SEATBELT LOOSENS

LAP-SASH SEAT BELT

If a seat belt will not stay tight, then a Gated 3-Bar Slide may be used to prevent loosening.

Before installing the restraint, join the lap-sash seat belt by using the Gated 3-Bar Slide stored under the carrier.

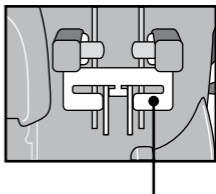

Gated 3-Bar Slide
under the carrier

- A. Hold the lap and sash straps together and fold as shown. Slide the inner strap into the Gated 3-Bar Slide followed by the outer strap.

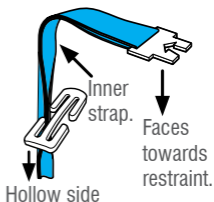

- B. The two straps should slide freely in the Gated 3-Bar Slide slot.

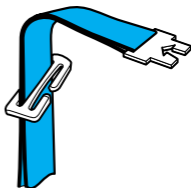

ALTERNATIVE INSTALLATION IF SEATBELT LOOSENS

- C. Repeat previous step A for the other slot in the Gated 3-Bar Slide.

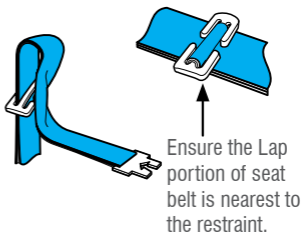

- D. Feed the straps through the Gated 3-Bar Slide to remove any slack.



Use this seat belt configuration to install the child restraint according to the instructions on pages 21 to 23.

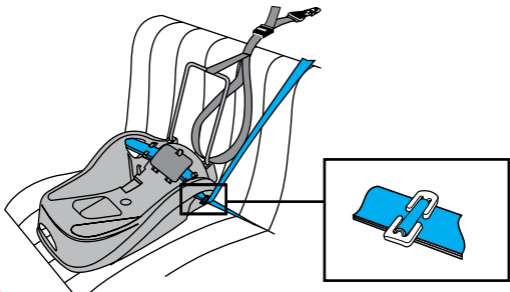

IMPORTANT:

Remove the gated 3 bar slide from the seat belt as soon as the child restraint is removed so that an adult can use the seat belt as a lap-sash seatbelt.

IN CASE OF ACCIDENT

If your restraint has been involved in a severe crash, you should destroy the restraint even if no damage is obvious. Some insurance companies offer car insurance which covers or partially covers the replacement of your child restraint. Contact your insurance company for further details. Your insurance company may require you to keep the child restraint for assessment, **but do not use the child restraint after a severe crash**. To assist you in making an accident insurance claim, cut out the following statement and include it with your claim.

NOTICE TO INSURANCE COMPANY CHILD RESTRAINT INVOLVED IN AN ACCIDENT

All Steelcraft child restraints are manufactured to Australian/New Zealand Standard AS/NZS1754-2010 which requires us to advise users of child restraints to "Destroy the entire restraint if it has been in use in a severe crash, even if no damage is obvious".

The joint Australian/New Zealand Standards committee CS/85, advise that this statement applies whether a child was in the child restraint or not. A severe crash, we consider as being one where the main body structure of the car is distorted.

There is no method of determining if the restraint has been damaged and we concur with the Australian/New Zealand Standard in recommending destruction of the child restraint.

This notice is to advise you of the requirements of the Australian/New Zealand Standard and our obligation in complying with the standards.

Please assist the owner of this restraint in their claim.

Britax Childcare Pty. Ltd.

(Incorporated in Victoria)

A.B.N 55 006 773 600 Head office and registered address:

99 Derby Road Sunshine Victoria 3020

PO Box 147 Sunshine Victoria 3020

Telephone: 1300 303 330

CONTACT DETAILS

CUSTOMER SERVICE

1300 303 330 - Australia 0508 688 822 - New Zealand

Distributed by:

AUSTRALIA

BRITAX CHILDCARE PTY. LTD. A Britax International company.

(Incorporated in Victoria) A.B.N. 55 006 773 600

99 Derby Road Sunshine, Victoria 3020, Australia

Phone: 1300 303 330

NEW ZEALAND

BRITAX CHILDCARE NZ. Limited. A Britax International company.

Phone: 0508 688 822

Due to our continuing program of development, Britax reserves the right to alter the specifications, colour or design without any further notice.

The Steelcraft, Safe-n-Sound, Strider and Strider PLUS trademarks are the property of Britax Childcare Pty. Ltd Australia.

The Britax trademark is the property of Britax Excelsior Limited - UK.

Visit the Britax website at: www.britax.com.au or email us at au-custserv@britax.com

©2011 Copyright Britax Childcare Pty Ltd. Australia. Patents Apply.

P/No. 2200778/F



www.britax.com.au