

Britax

Safe-n-Sound

Convertible Child Restraint

Featuring AHR Tilt & Adjust™

Series No. 7200/A/2010

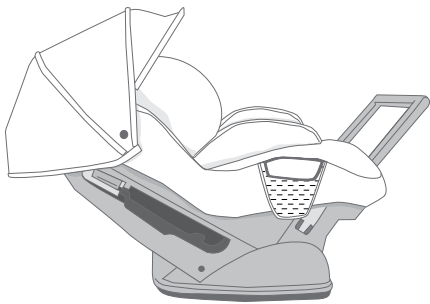

Rearward Facing

For use with children
up to approximately 12 months.

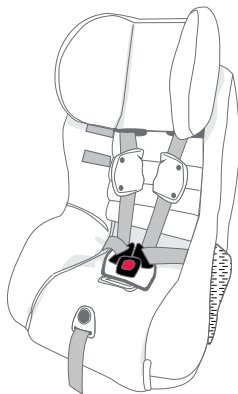

Forward Facing.

For use with children from
approximately 12 months to
approximately 4 years of age.

Instructions for Installation & Use



IMPORTANT: KEEP THIS BOOKLET IN THE PLACE PROVIDED ON THE CHILD RESTRAINT

Page

- 3 INTRODUCTION**
- 4 WARNINGS**
- 6 SHOULDER HEIGHT MARKERS A GROWING CHILD**
- 7 SHOULDER HEIGHT MARKERS THE NEXT STEP**
- 9 SPECIAL FEATURES: REARWARD-FACING**
- 11 SUITABLE FOR USE : REARWARD-FACING**
- 13 HOW TO SETUP**
- 19 HOW TO INSTALL**
- 25 HOW TO USE**
- 29 SPECIAL FEATURES: FORWARD-FACING**
- 31 SUITABLE FOR USE: FORWARD-FACING**
- 32 HOW TO SETUP**
- 36 HOW TO INSTALL**
- 43 CARE & MAINTENANCE**
- 48 ACCESSORIES**
- 50 TRAVELLING TIPS**
- 52 PRE-INSTALLATION ANCHOR FITTING**
- 56 FEATURES**
- 57 IN CASE OF ACCIDENT**

To be used only in a rearward-facing position for an infant until their shoulders reach the lower shoulder height marker (approximately 12 months of age). Then to be used in a forward-facing position until their shoulders reach the upper shoulder height marker (approximately 4 years of age).

Continue to use this child restraint until the child reaches this limit.

Do not use forward facing until child's shoulders are above the lower shoulder height marker.

Infants are at risk of serious injury if they face forward too early.

Children are at risk of serious injury if they move to booster seats too early.

Children that have outgrown this restraint are safest in a booster seat until their shoulders reach the upper shoulder height marker of the booster seat.

CAREFULLY READ ALL THE INSTRUCTIONS FOR INSTALLATION. IN THE EVENT OF DOUBT ABOUT THE METHOD OF INSTALLATION, CONSULT BRITAX CHILDCARE OR AGENT OR A CHILD RESTRAINT FITTING STATION AUTHORISED BY A RELEVANT TRANSPORT AUTHORITY OR, IN NEW ZEALAND, THE AGENT FOR THE VEHICLE.

No child restraint can guarantee absolute protection from injury in every crash. However, to ensure that your child gets all the protection designed into the restraint **PLEASE READ AND FOLLOW THESE INSTRUCTIONS EXACTLY** and use only Safe-n-Sound (Britax) recommended parts and accessories.

THIS RESTRAINT MUST BE ATTACHED TO A CHILD RESTRAINT ANCHORAGE POINT IN THE CAR. REFER TO CAR OWNER'S HANDBOOK FOR LOCATION OF ANCHORAGE POINTS. REFER TO A CHILD RESTRAINT FITTING STATION IF NO ANCHORAGE POINTS ARE IN THE MOTOR CAR.

Always store the instruction book in the pocket provided on the side or the back of the cover.

WARNINGS

- Use the restraint exactly as shown in the instructions.
- Fit the restraint firmly to the car seat.
- Fit the harness firmly to the child.
- A loose restraint or harness is dangerous.
- Supervision of children is needed because they may be able to undo buckles and adjusters.
- DO NOT LEAVE CHILDREN UNATTENDED IN THE CAR.
- Do not alter or modify this restraint.
- Repairs must only be done by the manufacturer or agent.
- Do not allow the restraint to come into contact with polishes, oils, bleach and other chemicals.
- Destroy the restraint if it has been in a severe crash, even if no damage is visible.
- DO NOT USE THIS RESTRAINT WITHOUT A COVER.
- Regularly check the restraint components, straps & other fitments for correct function and condition. Seek prompt repair.
- To ensure baby's back is evenly supported do not put more than one nappy on the baby and make sure the nappy is not thickly folded at the back.
- If an airbag is fitted in the desired seating position where the child restraint is to be fitted, follow the vehicle manufacturer's warnings and instructions.
- DO NOT USE A REAR-FACING CHILD RESTRAINT WHERE AN AIRBAG IS FITTED IN THE FRONT OF THE SEATING POSITION.
- The restraint should not be purchased or sold as a second hand item. It is recommended not to use child restraints older than 10 years as the protection in an accident may be reduced.
- THIS RESTRAINT IS NOT SUITABLE FOR USE WHERE THE ANCHORAGE STRAP MAY FALL INTO A SPLIT IN THE SEAT BACK (E.G. HATCHBACK OR WAGON).

WARNINGS

- The restraint should not be purchased or sold as a second hand item. It is recommended not to use child restraints older than 10 years as the protection in an accident may be reduced.
- The restraint is not intended to be a substitute baby cot or bed. It is only designed to enable safe transportation of children in motor vehicles. Do not leave a baby in the restraint for long periods of time.
- Upper anchorage straps and extension straps may be damaged by unsecured cargo in a collision. Secure or remove hazardous cargo before using this strap. Hatchback or wagon: Do not use the child restraint where the upper anchorage strap may fall into a split in the seat back.
- Protect all webbing from abrasion and cutting by sharp corners and edges.
- Do not lift the seat by the headrest.
- Do not store in areas that may get hot, like in car boots, roof space, beside shed walls which get hot in summer. Do not place heavy items on top of the seat as this may distort the plastic.

WARNING:

DO NOT LEAVE CHILDREN UNATTENDED IN THE CAR.

SHOULDER HEIGHT MARKERS A GROWING CHILD

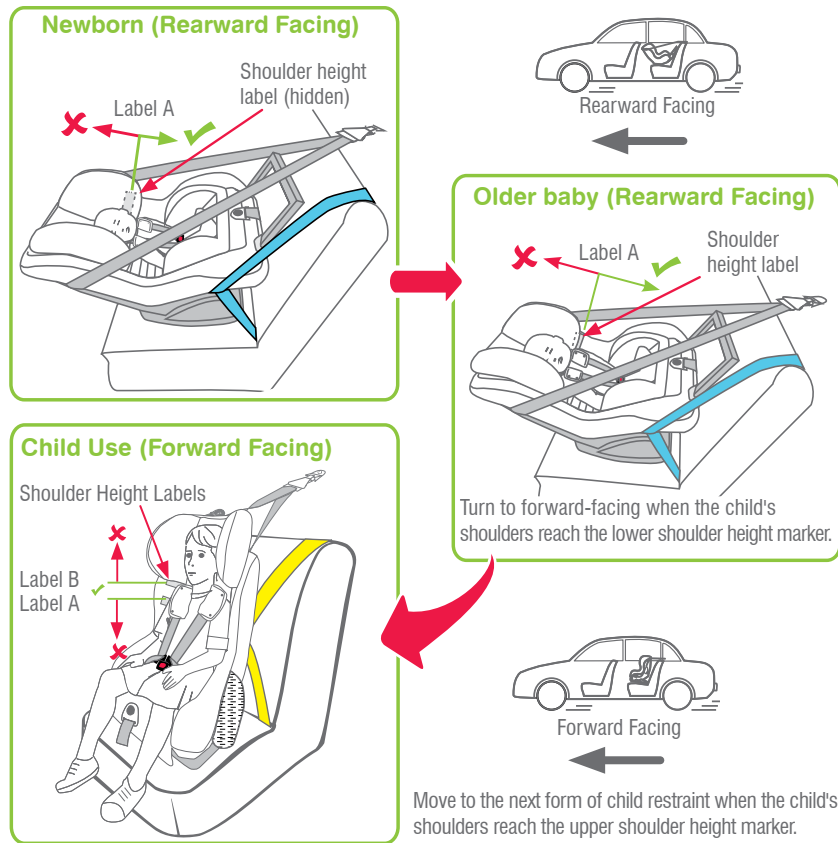

SHOULDER HEIGHT MARKERS THE NEXT STEP

Shoulder height markers are provided on this restraint for a visual indication that the child is safe to ride in this restraint. Do not turn to forward-facing until the child's shoulders reach the lower marker. Do not continue to use the restraint if the child's shoulders are above the top marker.

! IMPORTANT: FOLLOW THIS ADVICE.

LOWER SHOULDER HEIGHT MARKER : Label A

When the child's shoulders reach the lower marker, the child restraint must be turned to face towards the front of the vehicle or move the child to another Forward Facing seat with in built harness. Approximately 12 months of age.

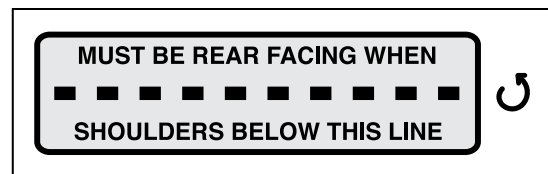

UPPER SHOULDER HEIGHT MARKER : Label B

When the child's shoulders reach this upper marker, the child is now too big for the child restraint. It is now time to move to the next child restraint. Approximately 4 years of age.

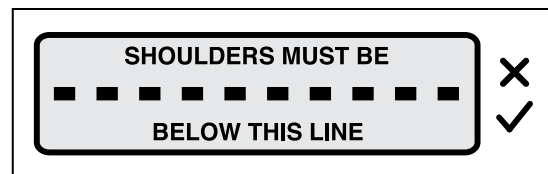

SHOULDER HEIGHT MARKERS THE NEXT STEP

For the next child restraint choose from:

- Convertible Booster Seat (Note: you can move to a convertible booster seat once the child's shoulders reach the lower shoulder height marker),

OR

- Booster Seat and an accessory Child Harness (A Child Harness must be used if the car is fitted with a lap only seat belt in the desired seating position),

OR

- Booster seat and lap-sash seat belt.

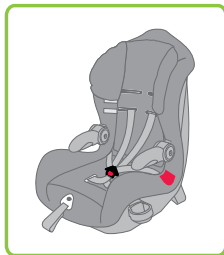

Convertible Booster seat used with internal harness until approximately 4 years and then as a booster seat.



Booster seat and accessory Child Harness.

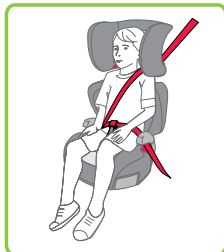

Booster seat and lap-sash seat belt.

SPECIAL FEATURES: REARWARD-FACING

To be used only in a rearward-facing position until the infant's shoulders reach the lower shoulder height marker (approximately 12 months of age).

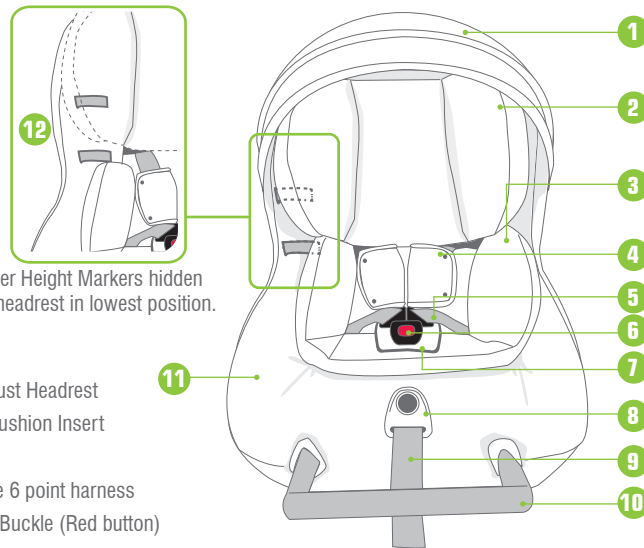

Shoulder Height Markers hidden under headrest in lowest position.

1. Canopy
2. AHR Tilt & Adjust Headrest
3. Infant Safety Cushion Insert
4. Shoulder Pads
5. Fully adjustable 6 point harness
6. Quick Release Buckle (Red button)
7. Crotch Pad
8. Harness Adjustment Button
9. Harness Adjustment Strap
10. Stabilising Bar for Baby use
11. Padded cover for baby's comfort (may vary in style)
12. Shoulder Height Markers (Hidden behind headrest)

SPECIAL FEATURES: REARWARD-FACING

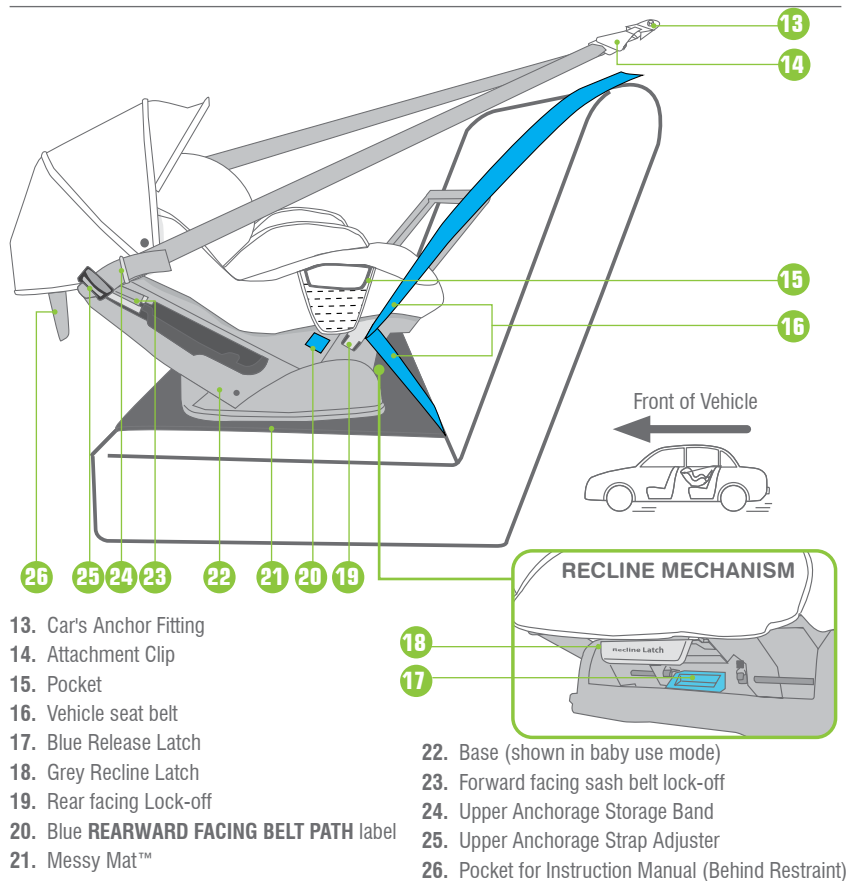

- 13. Car's Anchor Fitting
- 14. Attachment Clip
- 15. Pocket
- 16. Vehicle seat belt
- 17. Blue Release Latch
- 18. Grey Recline Latch
- 19. Rear facing Lock-off
- 20. Blue **REARWARD FACING BELT PATH** label
- 21. Messy Mat™

- 22. Base (shown in baby use mode)
- 23. Forward facing sash belt lock-off
- 24. Upper Anchorage Storage Band
- 25. Upper Anchorage Strap Adjuster
- 26. Pocket for Instruction Manual (Behind Restraint)

SUITABLE FOR USE: REARWARD-FACING

TO BE USED WITH A LAP SASH OR LAP ONLY SEAT BELT IN THE BACK OF MOST CARS WITH FORWARD-FACING SEATS.

To be used only in a rearward-facing position until the child's shoulders reach the lower shoulder height marker (approximately 12 months of age). Then to be used in forward-facing position until the shoulders reach the upper shoulder height marker (approximately 4 years of age).

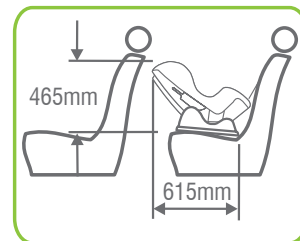

Continue to use this restraint in this rear facing mode until the child's shoulders reach the limit of the lower shoulder height marker before turning the seat to face forward. A baby's neck muscles may be unable to support their head thus the baby should remain rear facing until the neck muscles become stronger.

The purchaser should check the measurements between the front of the seat back of the rear seat and all front seats in the car in which the child restraint is intended to be used, to ensure that the space is sufficient. If you have the restraint check it fits in your car.

Regional Road Rules may prohibit the use of this restraint in the front seat until the child is 4 years of age. Check your Regional Road Rules for exemptions.

SUITABLE FOR USE: REARWARD-FACING

WARNINGS

DO NOT USE RESTRAINT IN REARWARD FACING MODE WITHOUT STABILISING BAR FULLY EXTENDED.

Do not use the restraint without the Upper Anchorage Strap correctly attached.

DO NOT USE A REAR FACING CHILD RESTRAINT WHERE AN AIRBAG IS FITTED IN FRONT OF THE SEATING POSITION.

Do not use on any vehicle seat which faces sideways or rearwards.



Do not allow the front seat to alter the installed position of the restraint. It is permissible to allow the restraint to touch the front vehicle seat.

Never leave babies or toddlers in a stationary car in the sun because of the risk of heat exhaustion. Ensure babies and toddlers have adequate ventilation and are shaded from direct sunlight through side or rear windows.

CHILD RESTRAINT ANCHORAGE

To use this child restraint, the car will need a child restraint anchor fitting in the seating position that you intend to use. Refer to the car owner's handbook.

If no anchor fitting is provided then you will need to install an anchor fitting. Refer to pages 52 to 55.

The anchor fitting is required for attaching the upper anchorage strap in both rear facing mode and forward facing mode covered later in these instructions.

HOW TO SETUP

INSTALLING INTO VEHICLE REARWARD FACING

A. The restraint is normally packaged in the fully upright child use mode so if you need to use it for baby use you must first fully recline the restraint. Convert the restraint to baby use mode by referring to steps below,

B. If Upper Anchorage Strap is folded up for storage under Storage Strap then lengthen. Fully press Adjuster Button (A) while pulling Upper Anchorage Strap (B) to lengthen.

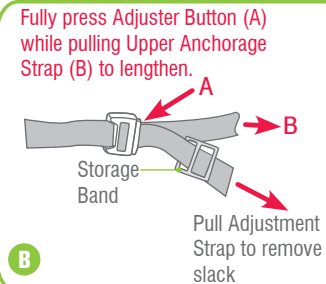

FULLY RECLINE IN CHILD USE MODE:

Place one hand on the front corner of the base firmly while with the other hand lifts the Grey Recline Latch up to unlock, continue pulling restraint forward until fully reclined. The Blue Release Latch prevents over reclining when installed forward facing. The seat belt may need to be slackened and retightened.

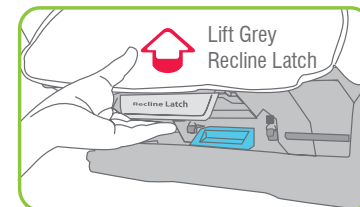

CONVERT TO BABY USE MODE:

Once fully reclined, press the Blue Release Latch located under the restraint body while with the other hand lift the Grey Recline Latch up to unlock, continue pulling the restraint forward until fully reclined into baby use mode.

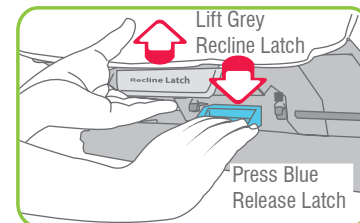

HOW TO SETUP

INSTALLING INTO THE CAR

A. Place the restraint rearward facing in the chosen seating position with the Messy Mat positioned centrally in the seating position.

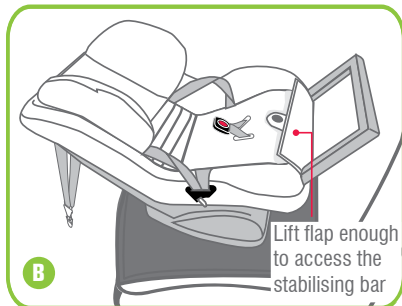

B. Lift the flap at the end of the seat sufficiently to access the stabilising bar, pull out stabilising bar and then gently push bar forward until a click is heard. Stabilising bar is now latched in place. Refit the flap.

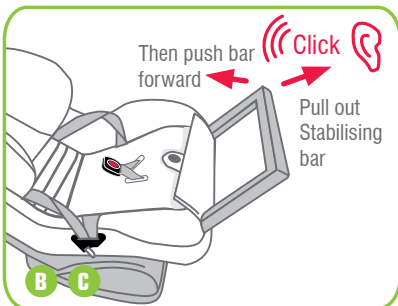

C. Undo the buckle and place the straps to each side.

HOW TO SETUP

D. Remove Infant Safety Cushion Insert, and gently lift headrest trim end, then pull backwards the centre panel flap, with the comfort pad from the inner seat of trim.

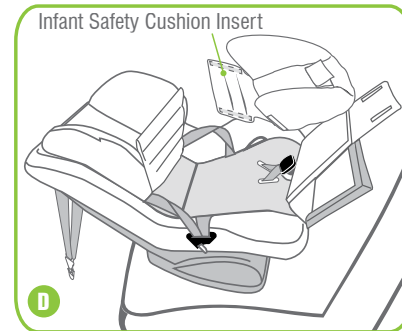

E. If using a Lap-sash seatbelt, disengage the rear facing Lock-off. Fully lengthen seat belt and feed the seat belt through the closest seatbelt path slot and pass across the seating surface behind the crotch buckle straps and through the opposite slot. Follow the blue - **REARWARD FACING BELT PATH** label.

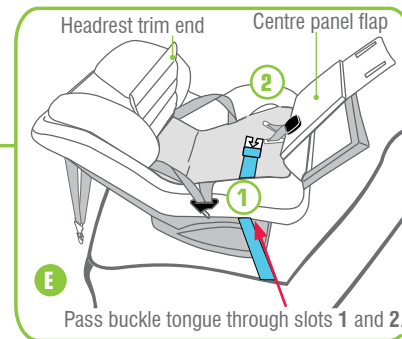

Blue - **REARWARD FACING BELT PATH** label.

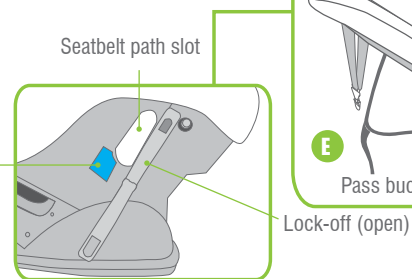

Lock-off (open)

E Pass buckle tongue through slots 1 and 2.

HOW TO SETUP

F. Engage seat belt buckle & tongue and tighten the seat belt allowing the sash to fully retract. Use the rear facing seat belt lock-offs to prevent the seat belt loosening. See illustrations on the next page. Do not use the lock-off if the buckle interferes with closing the lock-off.

Note: Seat belt buckle and tongue must not rest between restraint cover and restraint. If seat belt buckle is adjustable, adjust buckle as low as possible away from the restraint.

G. Replace the centre panel properly, ensure the harness buckle is through the panel, and reconnect the hook and loop to retain the cover. Then place back the headrest trim end along the backrest. For smaller babies replace the Infant Safety Cushion Insert. Do not use the Infant Safety Cushion if the child's shoulders reach the Lower Shoulder Height Marker. See page 23 and 24 for advice on positioning the shoulder straps and the headrest.

NOTE: Seat belt extenders should not be used if the seat belt is not long enough to secure the child restraint. If they are used then the buckle must not enter the seating zone.

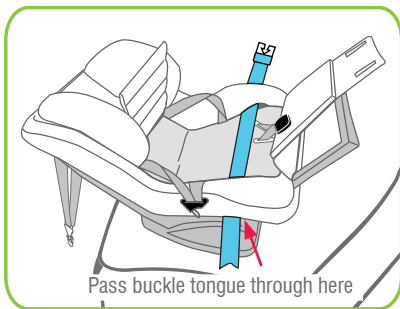

HOW TO SETUP

H. Align restraint centrally to the chosen seating position. Pull sash portion of seat belt until all slack is removed from Lap portion of seat belt so as to hold the restraint firmly against the vehicle seat back. For retractor seat belts. Allow excess belt to feed back into retractor. Lock the rear facing seat belt lock-off to prevent the seat belt slackening.

On the opposite side to the seat belt buckle, only pass the lap portion of the belt through the lock-off and lock in place (optional).

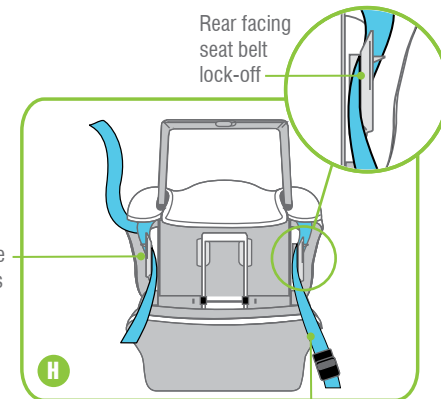

On the car seat belt buckle side, pass both lap and sash seat belt through the lock-off and lock in place.

If placing the restraint in a seating position with a lap only seat belt, tighten the seatbelt so as to hold the restraint firmly against the vehicle seat back.

HOW TO SETUP

I. Fit the attachment clip to the car's anchor fitting as shown. Make sure to remove as many twists as possible from the upper anchorage strap. Refer to the car owner's handbook for the location of the child restraint anchor fitting.

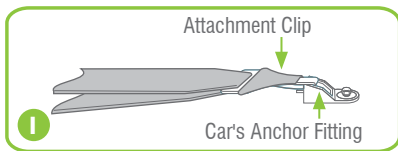

J. Tighten adjustable upper anchorage strap by pulling adjustment strap (C) to remove slack, but do not over-tighten causing the restraint base to lift off the vehicle seat. This will usually be done once the baby has been harnessed into the seat. Roll up excess strap tightly so the webbing is thick enough to be held in the storage band.

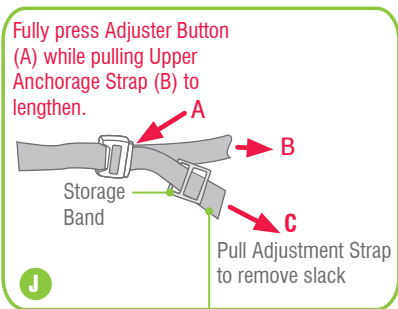

Roll up excess strap tightly so the webbing is thick enough to be held in the storage band.

HOW TO INSTALL

Ensure Upper Anchorage Strap is tightened, attached to the Anchor Fitting and that straps are the same length on both sides of Attachment Clip.

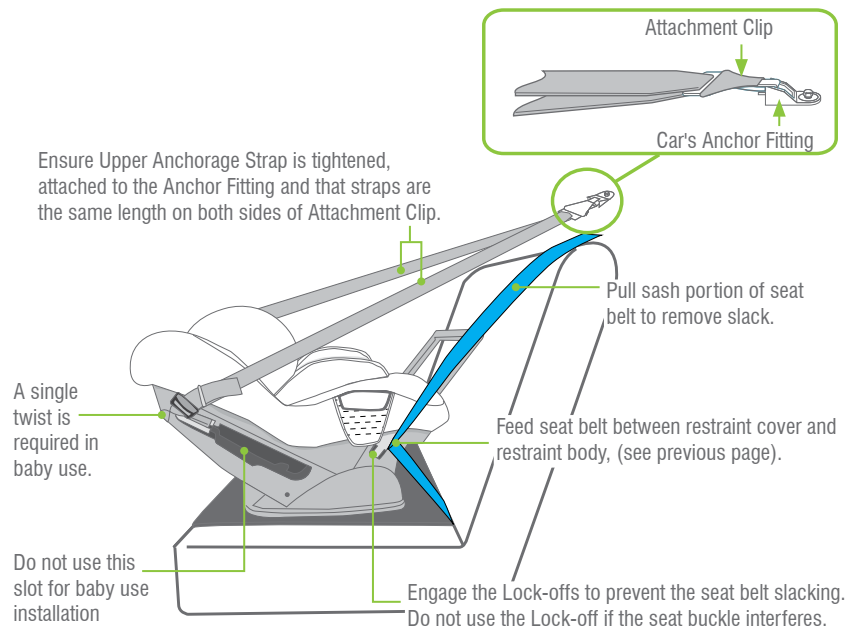

⚠ WARNINGS

DO NOT USE RESTRAINT IN REARWARD FACING MODE WITHOUT STABILISING BAR FULLY EXTENDED.

THE UPPER ANCHORAGE STRAP MUST ALWAYS BE FITTED WHEN THE CHILD RESTRAINT IS USED IN A VEHICLE.

ALWAYS ATTACH THE HOOK AND REMOVE THE SLACK.

HOW TO INSTALL

Important: If using an Extension Strap, positioning the Attachment Clip above the baby may lead to injury in an accident therefore make sure that the Attachment Clip is not positioned in front of the vehicle seat. Use a shorter extension strap or no extension strap.

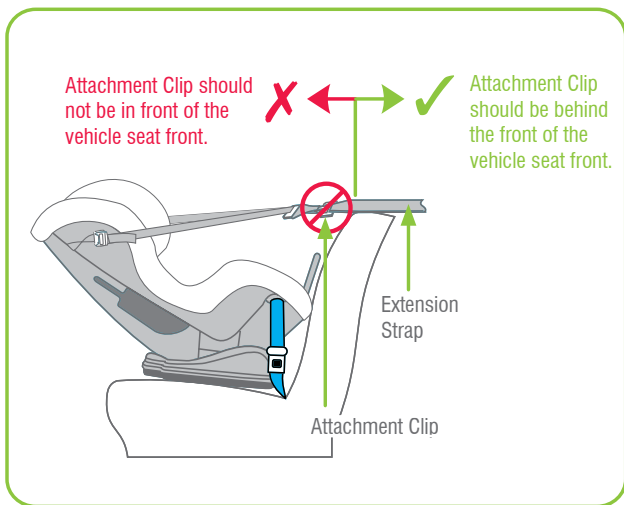

HOW TO INSTALL

ANGULAR ADJUSTMENT OF RESTRAINT

Some vehicle seats have more rearward slope than others. If the angle of the seat causes the baby to be too upright for comfort, the angle may be altered by placing a firm packing between the seat and the underside of the base. Packing can be a firmly rolled up towel or nappy.

Do not remove all of the rearward slope by over packing. Always leave a rearward slope angle of approximately 10 to 15 degrees as shown

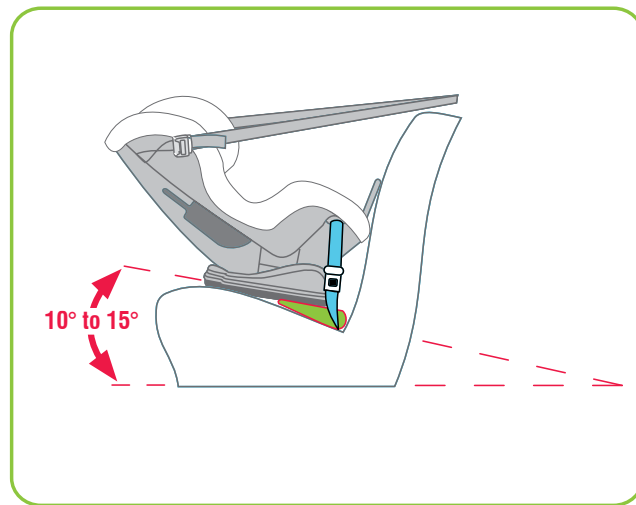

HOW TO INSTALL

ADJUSTING HARNESS STRAP HEIGHT & HEADREST: FOR BABY USE REARWARD-FACING

Correct fitment of the harness is very important as it restrains the baby in the restraint. The headrest must be in the correct position and the harness must fit firmly around upper torso of the baby and be positioned so as to leave the baby's arms and legs free.

For babies in rear facing mode the headrest must be in the position where the **top** of the shoulder strap slots are nearest to the child's shoulders, but not lower than the child's shoulders. Instructions for adjusting the headrest is on the next page. If your baby has reached the lower shoulder height marker then the restraint should be converted for "child use" (Refer to Forward Facing section starting on page 29).

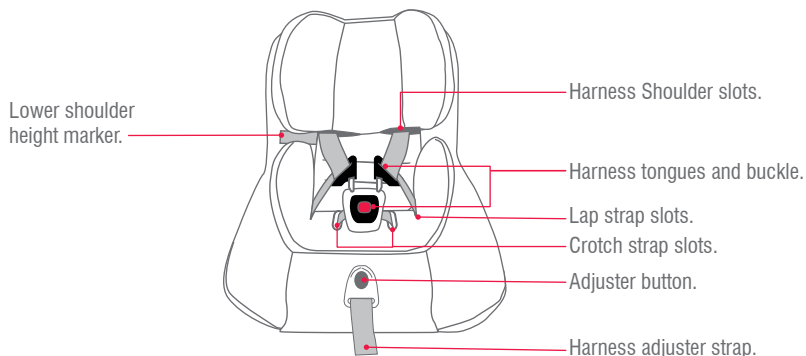

HOW TO INSTALL

1. The shoulder straps must be in the slots which are nearest to the child's shoulders, but not lower than the child's shoulders. There is only one set of slots so the seat will always have the shoulder straps in place.
2. Use the Infant Safety Cushion Insert when rear facing for smaller babies until their shoulders reach the Lower Shoulder Height Marker. Remove the Infant Safety Cushion for longer use whilst still in rear facing.
3. Discontinue the use of the Infant Safety Cushion Insert if there is insufficient room for the baby or shoulders reach the Lower Shoulder Height Marker.

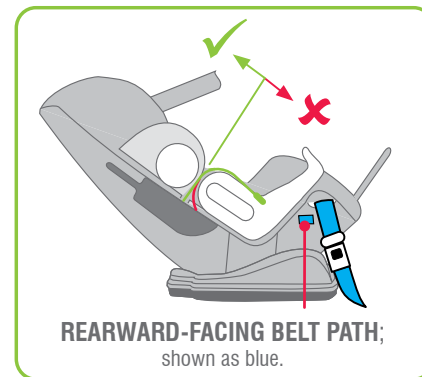

HOW TO INSTALL

ADJUSTING AHR TILT & ADJUST HEADREST AND HARNESS STRAP HEIGHT

A. Loosen the harness straps before adjusting the headrest.

B. You do not need to remove the restraint from the vehicle to adjust the harness or headrest positions. Small adjustments may be possible with the baby still in the seat, the baby will need to be supported to allow the headrest to be rotated forward for adjustment.

C. To adjust the headrest, gently pull the top of the headrest forward as shown (see illustrations), and pull up or push down so that the shoulder strap slot is level with or slightly above your child's shoulder.

D. Release headrest so that it moves back and locks into position. Ensure that it has locked in position by gently pushing down on it.

E. Ensure there are no twists in the harness strap and the buckle tongues face the correct way.

F. If the headrest is moved up, then down with the child in the seat, check that the headrest cover has not bunched up behind child's back which will cause discomfort.

Pull forward to unlock headrest



C

While holding forward, move up or down to desired position.

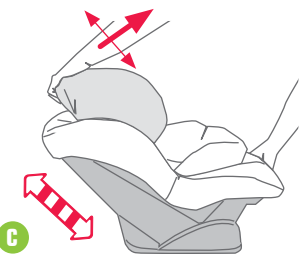

C

PLACING BABY INTO RESTRAINT

A. Ensure the headrest and shoulder straps are adjusted to the correct height for your child (see page 6 and 7).

B. Slacken the Upper Anchorage Strap and allow the straps to fall to the sides of the restraint for easy access to the baby.

C. Slacken Harness Straps by pushing and holding the Harness Adjustment Button, grasping BOTH shoulder harness straps and pulling out the desired amount of slack. Release harness adjustment button when there is enough slack.

D. Lay the baby on their back into restraint and fit harness as shown above. Make sure the baby is dressed to allow harness buckle to be pulled up between baby's legs e.g. a jump suit. Make sure the baby's arms and legs are free. Never wrap baby in a blanket before placing in restraint.

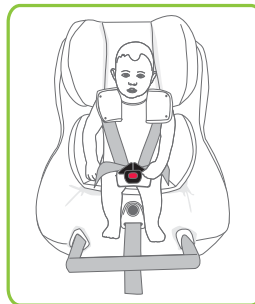

Lower shoulder height marker hidden when headrest is the lowest position.

Adjustable Headrest

Half twist in the Upper Anchorage Strap

Adjuster for the Upper Anchorage Strap

Harness shoulder straps

Slackened Upper Anchorage Strap

Pull Adjustment Strap to tighten the harness

Adjuster Strap

Harness Adjustment Button

D

HOW TO USE

HOW TO USE

E. Fit either harness tongue into the harness buckle followed by the other tongue until a click is heard. Should the second tongue not insert, press the red button and reinsert the tongues. Ensure secure engagement by pulling harness straps.

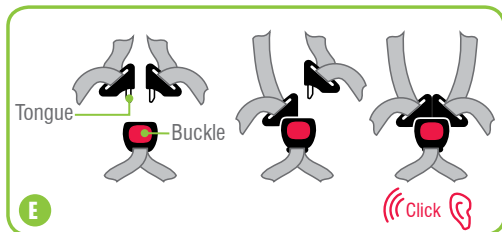

F. Remove slack from harness lap straps by pulling shoulder straps. Then pull the Adjuster Strap below the push button - See illustration D on page 25.

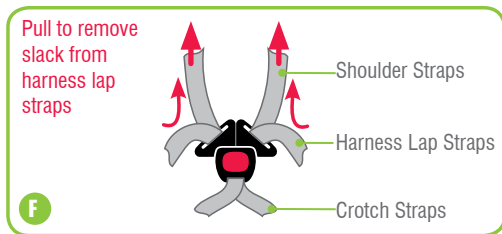

! CAUTION: A LOOSE HARNESS IS DANGEROUS.

Make sure that nothing is obstructing harness straps and that baby's arms and legs are free with the straps in the correct location - see previous page.

Do not use restraint if straps do not tighten and contact Britax Childcare Customer Service. Refer to back cover for details.

! IMPORTANT:

The Infant Safety Cushion Insert is designed to snugly support baby for extra support and comfort and must be used for smaller babies. Discontinue use when baby's shoulder's reach the Lower Shoulder Height Marker or the Insert is a tight fit or creates discomfort for larger babies.

HOW TO USE

G. Retighten Adjustable Upper Anchorage Strap by pulling Adjustment Strap to remove slack as shown.

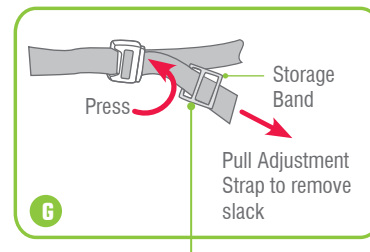

H. Always roll up excess strap tightly so the webbing is thick enough to be held in the storage band.

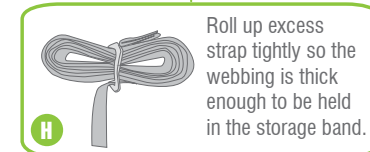

REMOVING BABY FROM RESTRAINT

A. Press Upper Anchorage Strap Adjuster Button while pulling Upper Anchorage Straps to slacken. Allow Upper Anchorage Straps to fall to the sides for easy access into restraint.

B. Push and hold the Harness Adjustment Button while pulling both Shoulder Harness Straps to slacken harness to the desired amount.

C. Press the red button on Harness Buckle then both Harness tongues will be released. Move each shoulder strap to baby's side then pick up baby.

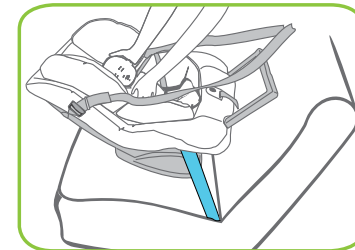

HOW TO USE

TO REMOVE RESTRAINT FROM VEHICLE

A. Disengage seat belt tongue from buckle and remove from restraint.

B. Release the stored strap and fully press Upper Anchorage Strap Adjuster Button (A) while pulling Upper Anchorage Strap (B) to slacken as shown right. In some vehicles loosening of the Upper Anchorage Strap may be difficult. If so, try pushing the restraint against the vehicle seat back or slightly lifting the restraint to release the tension.

C. Disengage Attachment Clip from Anchor Fitting. The child restraint is now disconnected.

See pages 32 and 33 for the storage of the stabilising bar and returning the seat to the upright position for forward facing mode or storage.

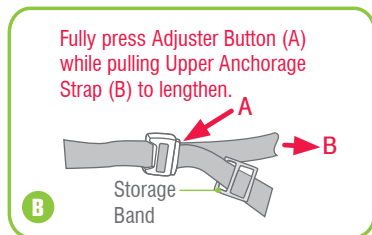

SPECIAL FEATURES: FORWARD-FACING

To be used only in a forward-facing position by children whose shoulder's have reached the lower shoulder height marker (approximately 12 months of age) until the shoulders reach the upper shoulder height marker (approximately 4 years of age.)

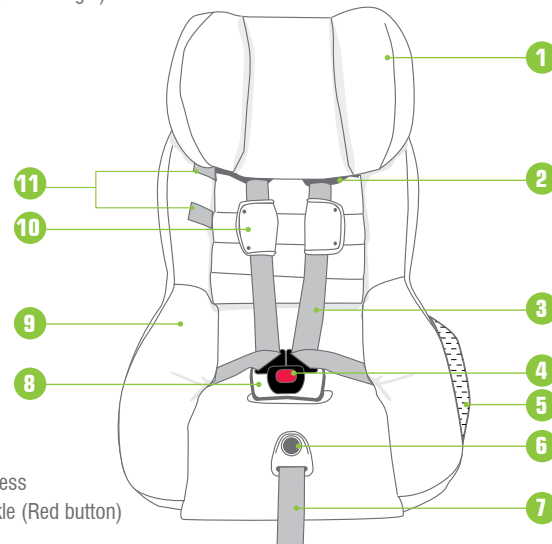

1. AHR Tilt & Adjust Headrest
2. Headrest Slots
3. Fully Adjustable 6 point harness
4. Quick Release Harness Buckle (Red button)
5. Pocket
6. Harness Adjuster Button
7. Harness Adjustment Strap
8. Crotch Pad
9. Padded Cover for comfort
10. Shoulder pads
11. Shoulder Height Markers (Hidden behind headrest)

SPECIAL FEATURES: FORWARD-FACING

- 12. Car's Anchor Fitting
- 13. Vehicle seat belt
- 14. Pocket for Instruction Manual (Behind Restraint)
- 15. Forward facing sash belt lock-off
- 16. Yellow **FORWARD-FACING BELT PATH** labels
- 17. Base (shown in child use mode)
- 18. Grey Recline Latch
- 19. Blue Release Latch
- 20. Messy Mat™
- 21. Rear facing Lock-off
- 22. Upper Anchorage Strap Adjuster
- 23. Upper Anchorage Storage Band
- 24. Adjuster Upper Anchorage Strap
- 25. Attachment Clip

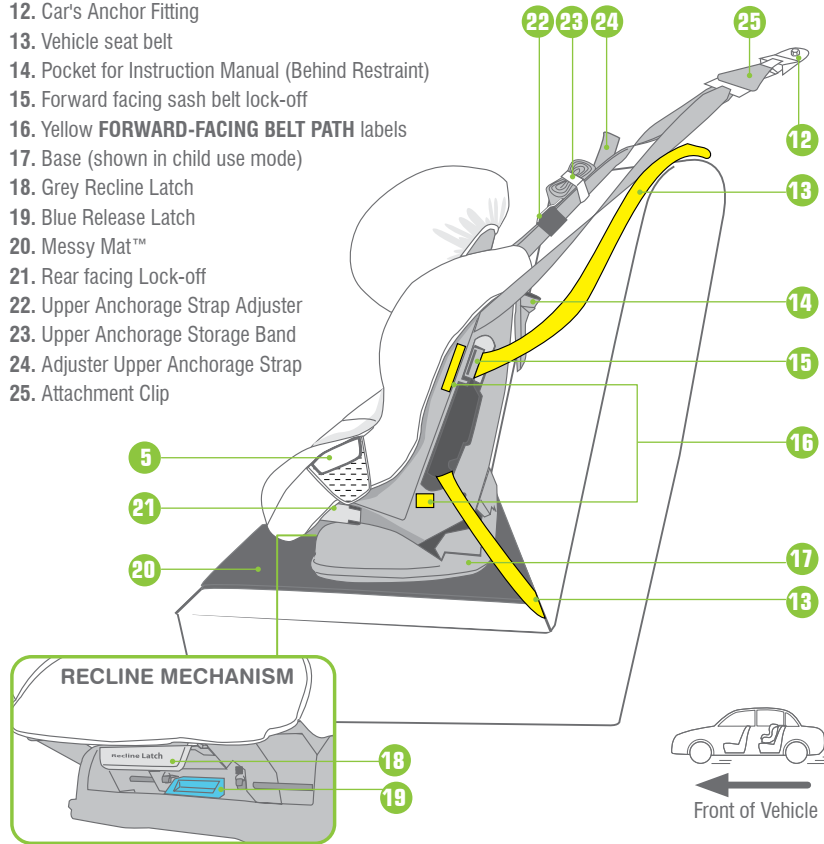

SUITABLE FOR USE - FORWARD-FACING

TO BE USED WITH A LAP SASH OR LAP ONLY SEAT BELT IN THE BACK OF MOST CARS WITH FORWARD-FACING SEATS.

Once the child's shoulders reach the lower shoulder height marker then the seat can be changed to the forward-facing position and used until the child's shoulders reach the upper shoulder height marker.

Continue to use this restraint in this forward-facing mode until the child's shoulders reaches the limit of the upper shoulder height marker. The child should not sit forward-facing until the baby's neck muscles are able to support their head. Do not move to a Booster Seat until the child has outgrown this child restraint.

Regional Road Rules may prohibit the use of this restraint in the front seat of the vehicle until the child is 4 years of age. Check your Regional Road Rules for exemptions.

⚠ WARNINGS

DO NOT USE RESTRAINT IN FORWARD-FACING MODE WITH THE REAR FACING MODE STABILISING BAR PULLED OUT.

Do not use the restraint without the Upper Anchorage Strap correctly attached.

If your vehicle is not fitted with an anchor point, please contact a Safety Restraint Fitting Station authorised by the relevant State Government Body for correct fitment of the restraint. In New Zealand contact the agent for the vehicle. The upper anchorage strap must be attached to an anchorage point using an extension strap if necessary.

Do not use on any vehicle seat which faces sideways or rearwards.

Do not use the Infant Safety Cushion Insert in Forward Facing 'Child Use' mode.

If an airbag is fitted in the desired seating position where the child restraint is fitted, follow the vehicle manufacturer's warnings and instructions.

Children are at risk of serious injury if they move to a booster seat too early.

HOW TO SETUP

INSTALLING INTO VEHICLE FORWARD FACING (UPRIGHT OR RECLINED)

- A.** Remove the seat from the vehicle by disengaging the seat belt and upper anchorage strap, refer to page 42.
- B.** Remove the Baby Infant Safety Cushion Insert as this is no longer required.
- C.** To store the Stabilising Bar, lift the cover at the end of the seat which uncovers the stabilising bar storage recess.
- D.** Press button on left side (facing seat) and gently push stabilising bar back and then down into the recessed area.
- E.** Re-attach the cover at the end of the seat.

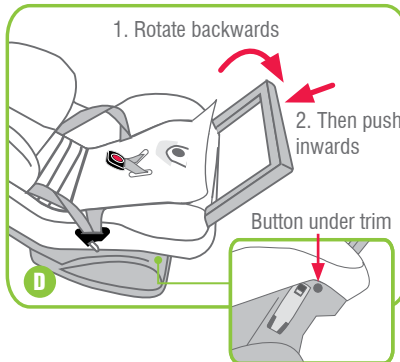
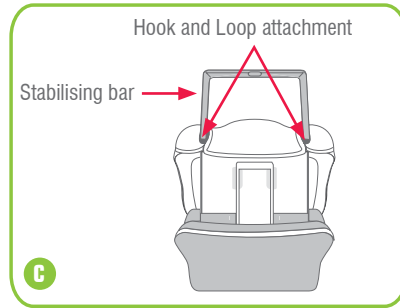

IMPORTANT:

DO NOT USE RESTRAINT IN FORWARD-FACING POSITION WITH THE STABILISING BAR PULLED OUT.

Do not recline into baby position when using restraint in forward facing child use mode.

Ensure harness and headrest are in the correct position (Refer to page 38).

HOW TO SETUP

- F.** Convert the restraint to child use mode by placing one hand over rear corner of the base and lift the top end of restraint with the other hand until audible click is heard.

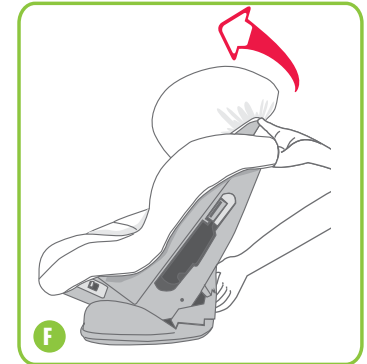

- G.** Determine whether an upright or reclined position is preferred and adjust if necessary.



FOR CHILD USE FORWARD-FACING

HOW TO SETUP

H. Place one hand on the front corner of base firmly, while with the other hand push the Grey Recline Latch up to unlock and push back until the restraint is at the desired position. Ensure the Grey Recline Latch is engaged into position by pushing on the restraint.

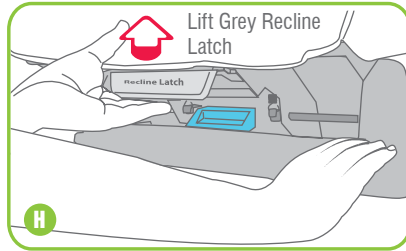

I. Position restraint in forward-facing mode and align restraint centrally to the chosen seating position as shown on page 33.

Some vehicle seat fabrics (particularly velours) may be damaged by a child restraint used continuously. We recommend the use of a messy mat or thick towel to keep the vehicle seat in good condition.

HOW TO SETUP

J. Fully lengthen seat belt. Thread the seat belt into child use seat belt path (yellow marker) as shown below, ensuring that the seat belt is behind the harness straps and that the lap part of the seat belt is below the hook as shown below, on each side.

NOTE: Seat belt extenders should not be used. If the seat belt is not long enough to secure the child restraint. If they are used then the buckle tongue must not enter the seating zone.

K. Engage seat belt buckle and tongue, ensure to remove all slack from lap part of seat belt by pulling sash belt. Adjust the seat belt to hold the restraint firmly against the vehicle seat. Feed the sash belt into seat belt lock-off pulling the sash tight through the lock-off. Press the lock-off lever to secure the seatbelt. For inertia/retractable seat belts, allow excess belt to feed back into retractor.

L. If using just a lap seat belt, thread the seat belt through the back of the seat following the belt path. Keep the belt under the hook on each side. Then engage the buckle and tighten the seatbelt so the restraint is held firmly against the car's back.

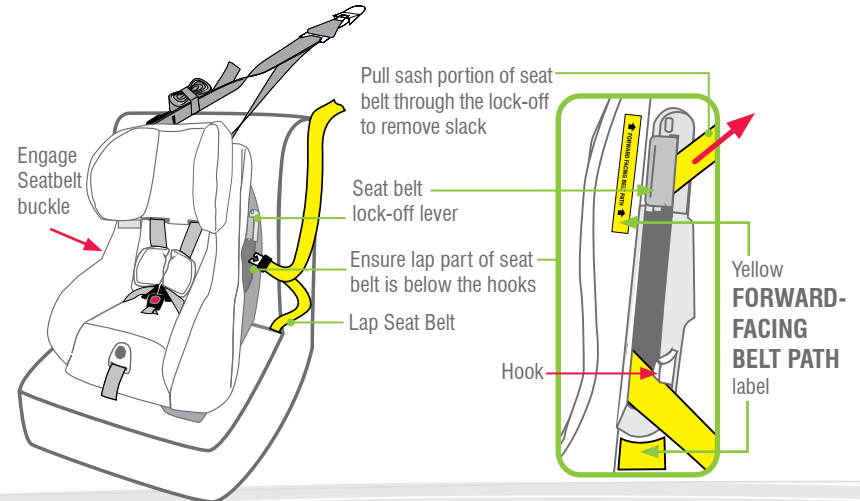

FOR CHILD USE FORWARD-FACING

HOW TO INSTALL

INSTALLING INTO VEHICLE FORWARD-FACING (UPRIGHT OR RECLINED)

M. Fit the attachment clip to the car's anchor fitting as shown. Make sure to remove as many twists as possible from the upper anchorage strap. Refer to the car owners handbook for the location of the child restraint anchor fitting.

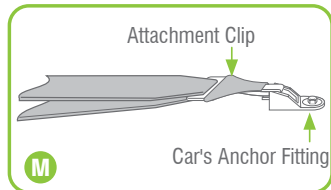

WARNING

Always attach the hook and remove slack

N. Tighten Adjustable Upper Anchorage Strap by pulling adjustment strap to remove slack as shown below, but do not over-tighten causing the restraint base to lift off the vehicle seat.

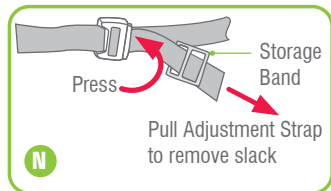

O. Roll up excess strap tightly so the webbing is thick enough to be held in the storage band and is away from child's reach.



CAUTION:

Always roll up the excess strap otherwise it may hang outside the car door or could strangle a child.

IMPORTANT:

Check that the belt is not twisted and the diagonal belt is only clamped by the lock-off which is located on the opposite side from the car seat buckle.

HOW TO INSTALL

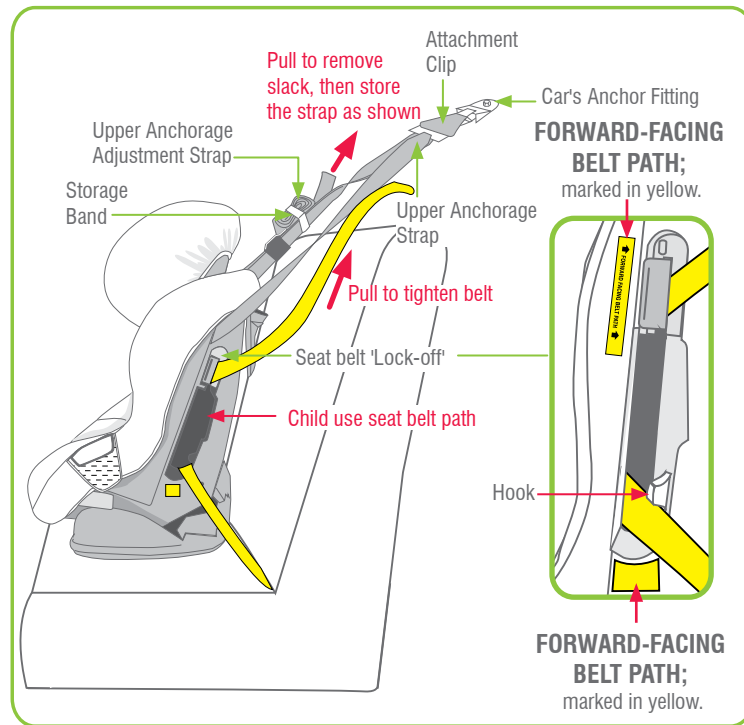

IMPORTANT:

Always roll up the excess Upper Anchorage Adjustment Strap.

FOR CHILD USE FORWARD-FACING

HOW TO INSTALL

ADJUSTING HARNESS STRAP HEIGHT AND HEADREST: FOR CHILD USE FORWARD-FACING

Correct fitment of the harness is very important as it restrains the child in the restraint. The harness must fit firmly around the upper torso of the child and be positioned so as to leave the child's arms and legs free.

The headrest must be in the position where the top of the shoulder slots are nearest to the child's shoulders, but not more than 25mm below the child's shoulders. If the headrest is in the top position and the shoulders are above the upper shoulder height marker then the restraint should not be used; move to next type of restraint (see pages 8 and 9).

The shoulder straps must be in the slots which are nearest to the child's shoulders, but not more than 25mm below the child's shoulders.

Note: This child restraint does not require the strap to be disconnected to adjust their height, only the headrest needs to be moved to adjust the shoulder strap position.

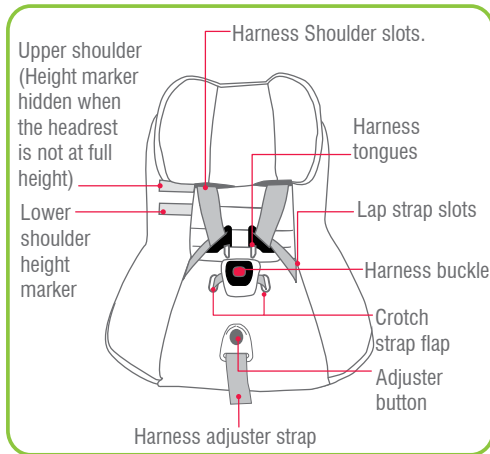

HOW TO INSTALL

ADJUSTING AHR TILT & ADJUST HEADREST AND HARNESS STRAP HEIGHT

A. Loosen the harness straps before adjusting the headrest.

B. You do not need to remove the restraint from the vehicle to adjust the harness or headrest positions. Small adjustments may be done with the child the seat, the child will need to lean forward to allow the headrest to be pulled forward.

C. To adjust the headrest, gently pull the top of the headrest forward and then pull up or push down so that the shoulder strap slots are level with or slightly above your child's shoulders. If the headrest is just above the shoulders then the harness level will be correct.

NOTE: For comfort ensure the bottom edges of the headrest are not contacting the child's shoulders.

D. Release headrest so that it moves back and locks into position. Ensure that it has locked in position by gently pushing down on it.

E. Ensure there are no twists in the harness strap and the buckle tongues face the correct way.

F. If the headrest is moved up, then down with the child in the seat, before use, check that the headrest cover has not bunched up behind child's back.

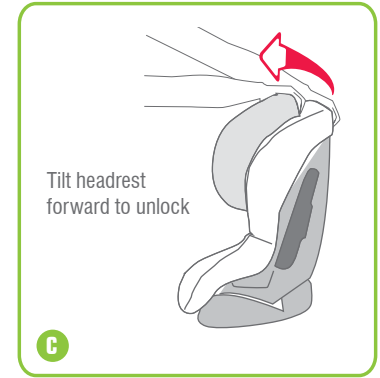

C

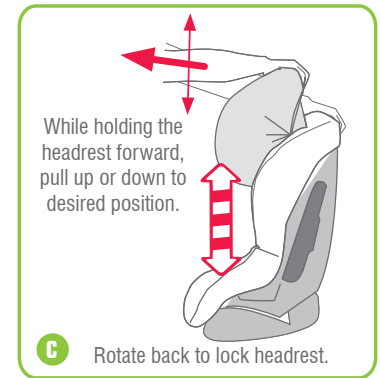

C

Rotate back to lock headrest.

FOR CHILD USE FORWARD-FACING

HOW TO INSTALL

PLACING CHILD IN THE RESTRAINT

A. Lengthen harness by pushing and holding the Harness Adjustment button while pulling on either shoulder strap until the harness will accommodate the child. Release harness adjustment button when there is enough slack and place harness straps on each side of the seat.

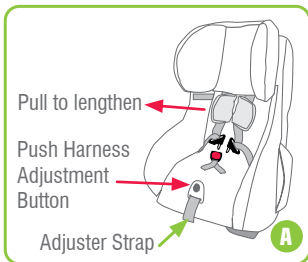

B. Place child in the restraint and feed each arm through shoulder straps. Pull harness buckle up between child's legs.

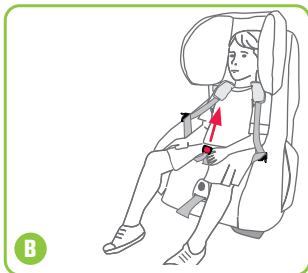

C. Fit either harness tongue into the harness buckle followed by the other tongue until a click is heard. Should the second tongue not insert press the red button and reinsert the tongues. Ensure secure engagement by pulling harness straps.

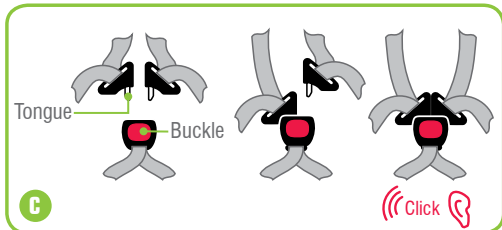

HOW TO INSTALL

D. Ensure all slack is removed from harness lap straps by pulling shoulder straps to adjust harness to a comfortable but firm fit. Check that the slack in straps is removed. Shoulder Harness Straps must fit firmly to the child. A loose harness could result in serious injury in an accident.

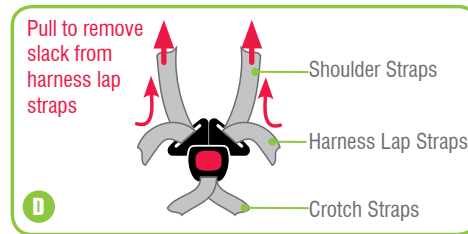

Do not use restraint if straps do not tighten and contact your local authorised service agent for repair.

⚠ CAUTION:
A LOOSE HARNESS IS DANGEROUS.

TO REMOVE CHILD

Press red button on Harness Buckle then both Harness tongues will be released. Lift the shoulder straps from the child's shoulders.

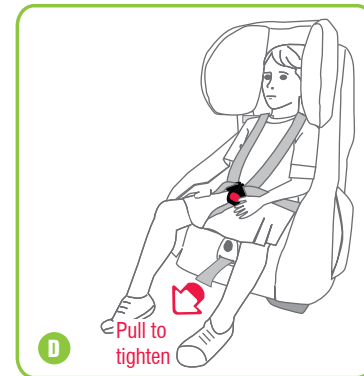

FOR CHILD USE FORWARD-FACING

HOW TO INSTALL

TO RECLINE RESTRAINT

The child restraint may be reclined or positioned upright without removing the child from the restraint. Lift Grey Recline Latch and push or pull to get the desired recline. There are 4 recline positions. You will be able to gain partial recline from upright position lifting the Grey Recline Latch up and pulling the seat forward (see page 13). The extent of the recline will be limited by the location of the anchorage point. Loosening of the upper anchorage strap may be required when positioning the restraint to either an upright or reclined position. Once the required position has been determined always tighten the upper anchorage strap, tighten the car's seat belt and close the Lock-off.

Lift Grey Recline Latch up while moving restraint into desired recline position.

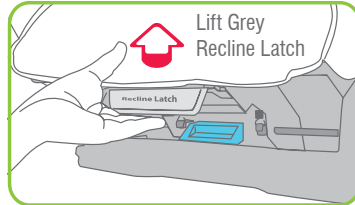

TO REMOVE RESTRAINT FROM VEHICLE

- Disengage seat belt tongue from buckle and remove from restraint.
- Release the stored strap and fully press Upper Anchorage Strap Adjuster Button (A) while pulling Upper Anchorage Strap (B) to slacken as shown right. In some vehicles loosening of the Upper Anchorage Strap may be difficult. If so, try pushing the restraint against the vehicle seat back or slightly lifting the restraint to release the tension.
- Disengage Attachment Clip from Anchor Fitting. The child restraint is now disconnected.

Fully press Adjuster Button (A) while pulling Upper Anchorage Strap (B) to lengthen.

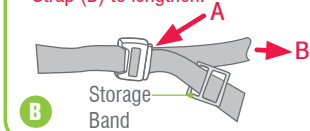

CARE & MAINTENANCE

REGULAR CARE OF THIS RESTRAINT:

Please check the following items regularly to ensure the safety of your child:

- Check the webbing for fraying.
- Check that the buckle clicks and is not sluggish or sticky in operation.
- Ensure there are no cracks in moulding or the plastic moulding.
- Check the harness adjuster is operating and is clamping the webbing.
- If any part of the restraint is cracked or broken, seek repair immediately or replace the child restraint.
- Ensure the buckle is free of fluff, liquid or other matter that may enter the buckle slots. If the buckle engages sluggishly, clean it as detailed on the next page.

SEAT

Use only mild soap and water to clean all metal and plastic parts of the restraint. Do not use chemicals or cleaning agents.



CARE & MAINTENANCE

TO CLEAN HARNESS BUCKLE:

If sticky liquids such as baby formula, fruit juice, etc. get inside your Harness Buckle, it may become sluggish. An indication of a sluggish Harness Buckle is that you cannot hear a click when engaging the Harness Tongues. To restore the Harness Buckle to good working order it needs to be cleaned as follows:

- From the underside of the restraint pull each crotch 3-bar slide then turn 3-bar slide and push through each slot to remove the Harness Buckle from the restraint.
- Place the Harness Buckle under warm (max. 40 degrees Celsius) running water as shown below. Let the water run through the mouth of the buckle for five minutes.
- Engage and disengage the Harness Tongues and Buckles several times until a strong audible click is heard when inserting the last tongue.
- If you still cannot hear a strong audible click after engaging the Harness Tongues and Buckle, then repeat cleaning several times. If the Harness Buckle cannot be returned to its original working condition then contact Britax Childcare Customer Service.
- Refit the harness buckle to the restraint with the red button facing out and feeding each 3-bar slide through appropriate slot.

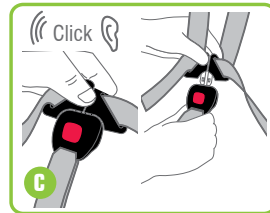
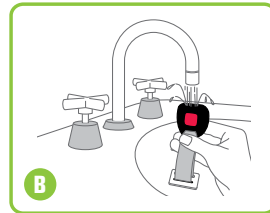
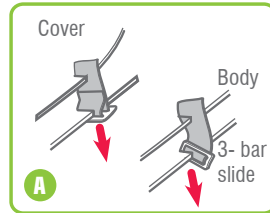

CARE & MAINTENANCE

COVER (STYLE MAY VARY)

The restraint has a flame retardant cover which is removable for cleaning. Cleaning instructions are on the care label attached to the cover. If fluffy cover is fitted then washing cover prior to use will remove excess fluff.

Drying the Infant Safety Cushion Insert will take additional time as the impact foam will absorb moisture. Before washing re-engage the hook and loop on the cover and Seat Pad to prevent the 'hook' damaging the fabric.

The cover has been designed to protect your child when seated in the restraint. Care should be taken if children either eat or drink while in the restraint as some food or drink products may cause damage or marking to the cover. Wash or clean immediately.

Do not pull sticky items from covers as the cover may be damaged - soak in water and gently remove.

! VERY IMPORTANT:

**Only use this child restraint with the cover supplied or a manufacturer-
authorised replacement cover with identical shoulder height markers.**

TO REMOVE COVER:

- Remove the restraint from vehicle.
- Disengage harness tongues from harness buckle.
- Remove any accessories such as the Infant Safety Cushion Insert.
- Remove headrest cover and seat trim cover as follows.
 - Hook the two elastic loops from under the headrest, Pull headrest slightly forward and lift elastic sitting behind the headrest. Lift over and peel headrest trim away from seat.

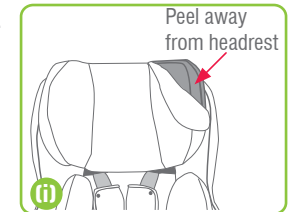

CARE & MAINTENANCE

(ii). To remove trim cover, unhook elastic trim body from behind the restraint and at the front of the restraint underneath the stabilising bar. Peel away from restraint while feeding through the Crotch buckle, Harness Tongues and strap through the lap and crotch strap slots in the cover.

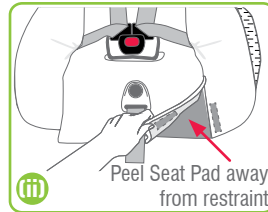
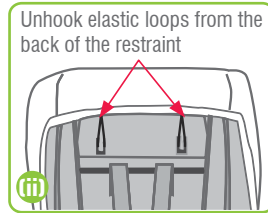

(iii). Peel away from restraint while feeding through the Crotch buckle, Harness Tongues and strap through the lap and crotch strap slots in the cover.



CARE & MAINTENANCE

TO REPLACE COVER:

- Feed the Harness Tongues and shoulder straps through Lap strap slots.
- Stretch trim cover over the top of the restraint first, then the sides of the child restraint, and then stretch the cover around the rim of the restraint.
- Re-fit the Seat Cover attachments.
- Feed Crotch Buckle through slots in cover.
- Ensure trim is stretched over Push Button housing
- Fit headrest cover over headrest and feed harness thru open slots in cover, ensure elastic is at the rear of headrest, behind cushions.
- Refit Infant Safety Cushion Insert, if required.
- Ensure the harness straps are not twisted.

TO REPLACE INFANT SAFETY CUSHION™ INSERT

The Infant Safety Cushion™ Insert is designed to snugly support baby for extra support and comfort and must be used for small babies when Rearward-Facing. Discontinue use when the Infant Safety Cushion Insert is tight fit or creates discomfort for larger babies. Do not use when in Forward-Facing mode.

- Disconnect buckle and place insert under shoulder and lap straps.
- Attach hook and loops on both sides of Insert.
- Feed the crotch strap through the flap in the Infant Safety Cushion Insert and re-connect buckle.
- Tuck the flap underneath the Infant Safety Cushion Insert.

Note: Discontinue the use of Infant Safety Cushion Insert once the child's shoulders reach the Lower shoulder Height Marker.

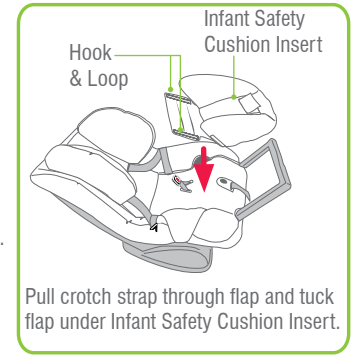

ACCESSORIES

IMPORTANT:

ONLY USE SAFE-N-SOUND SEAT COVERS AND ACCESSORIES THAT ARE DESIGNED AND TESTED FOR USE WITH THIS PRODUCT.

The following instructions apply to accessories that may be supplied with this restraint at point of purchase. If not, a variety of accessories are available from various retailers of Safe-n-Sound products.

CANOPY

- A.** Attach the elastic straps at the back of the canopy to the hooks at the rear of the restraint.
- B.** Attach together the press studs on the ends of the hood on the sides of the trim.
- C.** Pass hook and loop strap through loop attached to the hood.

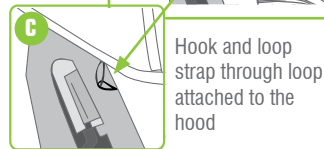
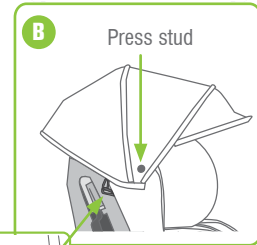
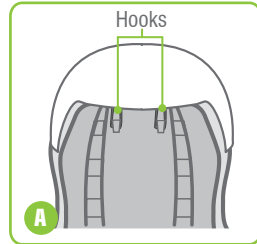

POCKETS

The pockets sewn on the trim are designed for your convenience. They can hold those necessary items that you need at a moments notice. e.g. Bottle, face washer, toy etc. They can also hold a CD or MP3 player.

CAUTION:

If using the pocket to store filled bottles, please ensure contents are not contaminated due to prolonged storage. Ensure contents are not crushed by car door when closing.

ACCESSORIES

CROTCH PAD

The Crotch Pad is designed to provide extra comfort for baby or child and is fitted to the restraint as follows: Feed Crotch Buckle through the slot in crotch pad as shown.

SHOULDER PADS

Shoulder Pads are designed to provide extra comfort for baby or child and are easily fitted to the shoulder harness straps by:

- A.** Pull apart fasteners and remove shoulder pads from harness.
- B.** Re-fit shoulder pads to harness and attach fasteners for use.

MESSY MAT™

The messy mat has been specifically designed to protect your vehicle seat from children's shoes rubbing against it. If the Messy Mat™ has been supplied it must be used to protect the car upholstery.

Place pocket on edge of seat, smooth back toward seat join ('A') and fit in any excess Messy Mat™ into the join of the car seat ('A').

CAUTION:

The Messy Mat™ pocket is only for small, light items. DO NOT overload the pocket with heavy, bulky items as this may damage the pocket or cause passengers to trip over them.

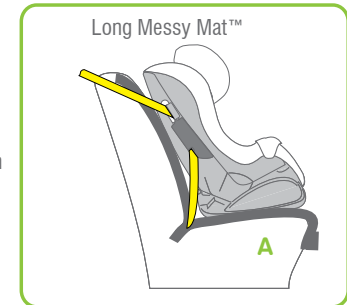
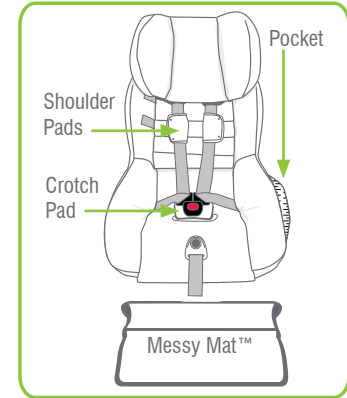

TRAVELLING TIPS

SAFETY

Never hold a baby in arms when riding in a motor vehicle. In this position the baby could be thrown against the dashboard, windscreen or other occupant and suffer serious injury or death.

When riding in a motor vehicle never nurse a baby and use the same seat belt for both of you. In this position the baby or child could be crushed.

Children must be secured in appropriate restraints at all times when the car is in motion. Children travelling unrestrained and standing up in the car are in danger of serious injury or death. Traffic regulations in all states require children to be secured in child restraints or adult seat belts where available.

Plan your trip with frequent comfort stops to reduce stress on babies, young children and driver. Keep the car well ventilated to reduce heat stress. Two car windows should be kept open to maintain a good flow of fresh air if air conditioning is not used.

Never leave babies or toddlers in a stationary car in the sun because of the risk of heat exhaustion.

Ensure babies and toddlers are adequately shaded from direct sunlight through side or rear windows. Be on guard against carbon monoxide poisoning which can occur through only a slight leak in the exhaust system while travelling in a closed car.

Securely stow all heavy objects, feeding bottles, etc. that could become missiles during an accident and cause injury to any occupant.

CLOTHING

Take several changes of clothing and bibs for possible car sickness. Disposable nappies and liners are very handy while travelling. Since it is often warmer in the car, dress the baby in light clothing. When cooler, it is easier to place a blanket over the baby than it is to remove the baby from the restraint and change clothes.

TRAVELLING TIPS

FEEDING

Never breast feed a baby while car is in motion. Babies will require extra feeding if travelling in the heat. For bottle fed babies, make up the bottles and refrigerate before leaving home for a day trip. Place in a cool bag and reheat as needed with hot water from a thermos.

Alternatively, bring boiled water in a thermos and pre-measured amounts of baby formula in small containers. Use the water from the thermos to mix with the formula when required. Regardless which method is used, it is always a good plan to carry some boiled water in a sterile container or bottle.

Do not attempt to carry warm milk because germs multiply rapidly in warm milk.

PRE-INSTALLATION ANCHOR FITTING

Consult the vehicle owner's handbook for location of anchorage fittings or anchorage points and the possible use of spacers. Some vehicles may have an anchor fitting fitted by the vehicle manufacturer. If anchorage points cannot be found refer to car manufacturer or local child restraint fitting station or traffic authority for optimum position of anchorage point and the use of spacers.

UPPER ANCHORAGE STRAP

IMPORTANT:

THE ATTACHMENT CLIP COVER MUST ALWAYS BE USED AS IT PREVENTS THE RISK OF INCORRECT FITMENT OF THE ATTACHMENT CLIP TO THE ANCHOR FITTING. ALWAYS ENSURE THAT THE ATTACHMENT CLIP IS CORRECTLY ENGAGED TO THE ANCHOR FITTING AND NOT HOOKED OR FITTED TO ANY OTHER OBJECT BEFORE EACH USE OF THE RESTRAINT. THIS IS ESPECIALLY IMPORTANT IN VEHICLES SUCH AS STATION WAGONS, VANS, HATCH BACKS OR VEHICLES WITHOUT A FIXED PARCEL SHELF, SINCE THE ANCHOR POINT IS USUALLY NOT VISIBLE.

IMPORTANT INSTALLATION NOTE:

In some vehicles the anchor fitting in the rear vertical panel can only be installed in one way. Please refer to vehicle owner's handbook or a child restraint fitting station for correct method.

PRE-INSTALLATION ANCHOR FITTING

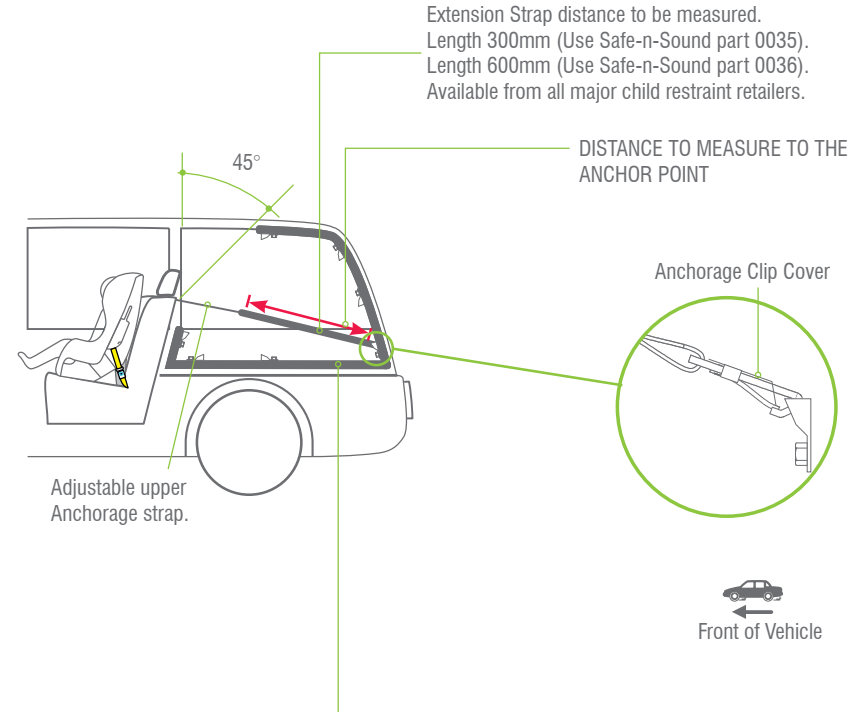

The shaded areas of this diagram illustrate the possible locations of the anchor fitting. Within each shaded area is an anchor fitting showing the correct way to install the fitting. Ensure the anchor fitting is aligned as illustrated unless stated otherwise in the vehicle owner's handbook.

PRE-INSTALLATION ANCHOR FITTING

IF THE CAR IS FITTED WITH CHILD RESTRAINT ANCHORAGE POINT

Locate the anchorage point behind the rear seating position. (Consult the car owners handbook for the location of the anchorage point). The anchorage point should be directly behind and central to the restraint. Remove thread plug from the parcel shelf/floor/roof, etc. and install anchor bolt and fitting as shown in Fig 1.

CAUTION: DO NOT OVERTIGHTEN ANCHOR BOLT. OVERTIGHTENING MAY FRACTURE OR BREAK BOLT. MAXIMUM TORQUE IS 20 N.M. (14.75 ft.lb.)

Note: Minimum of five full turns of anchor bolt is required before tightening force is applied.

IF THE CAR IS NOT FITTED WITH CHILD RESTRAINT ANCHORAGE POINTS

For Sedans only - Drill 9mm diameter hole in the parcel shelf on the centre line of the seating position as shown in Fig 3. Before drilling the hole, check the underside for accessibility. Install the anchor bolt as shown in Fig 2.

For vehicles other than Sedans - In Australia, consult your nearest child restraint fitting station or traffic authority for vehicle inspection to find the best, correct position for the placement of the anchorage point, and for the correct attachment bolt length and use of spacers. In New Zealand, consult the agent for the vehicle.

Note to Queensland purchasers: The installation of anchorage points must be approved by authorised officers appointed by Queensland Transport. Authorised officers can be sourced from all Queensland Transport Customer Service and Queensland Ambulance Service Centres.

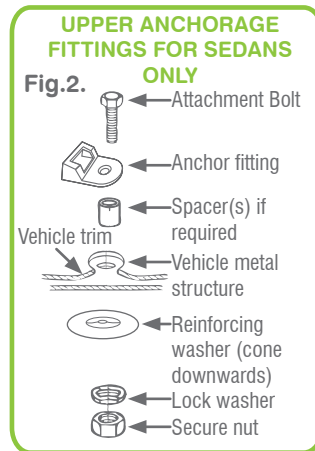
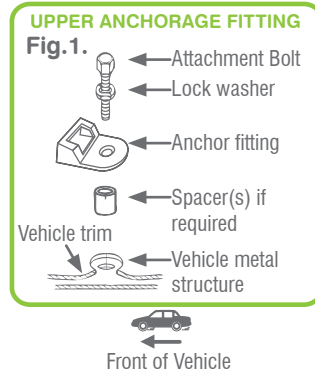

PRE-INSTALLATION ANCHOR FITTING

ONLY USE A 5/16 UNC GRADE 5 BOLT. IF THE BOLT IS NOT THE CORRECT LENGTH THE CAR MANUFACTURER'S HAND BOOK CAN PROVIDE ADVICE ON THE CORRECT LENGTH BOLT.



CHILD RESTRAINTS MUST NOT BE ATTACHED TO UNSOUND METAL OR TO WOOD, OR SYNTHETIC STRUCTURES. WHEN DRILLING 9 MM HOLE DO NOT DRILL THROUGH FUEL LINES, FUEL TANKS, ELECTRICAL WIRING, OR RADIO SPEAKERS. WEBBING STRAPS MUST BE PROTECTED FROM SHARP CORNERS AND EDGES. THE ANCHOR FITTING MUST BE USED ONLY AS DESCRIBED ABOVE. IT MUST NOT BE HOOKED ONTO ANY OTHER OBJECT.

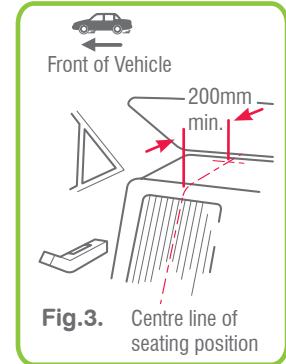
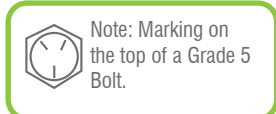

CAR INSTALLATION ACCESSORIES

(From retailers of Safe-n-Sound products)

EXTRA ANCHOR KITS: Available for using the restraint in additional cars.

Re-order no: 0038

EXTENSION STRAPS: May be required for cars without a fixed parcel shelf.

Re-order no: 0035 (length 300mm) or

0036 (length 600mm)

GATED 3-BAR SLIDE (Locking clip): For converting lap-sash seat belt to lap belt, and to obtain a better fit to the car where the fitted lock-off may not be suitable. Most cars will not need this, Re-order no: 0215.

FEATURES

- AHR Tilt & Adjust is a unique adjustable head restraint developed to be adjusted as your child grows.
- The deep side wings are EPS lined, designed to contain and protect the head in a side impact crash.
- The unique Tilt & Adjust feature avoids re-harnessing of the seat making it easier and safer to use. This means no need to rethread harness, reducing the risk of installing incorrectly.
- Converts from a rearward-facing into a forward-facing child seat. Child can remain rearward-facing up to approximately 12 months.
- Unique 'Infant Safety Cushion™ Insert' provides increased protection for small babies.
- This insert includes composite material support pad on each side to absorb energy on the babies torso during a side impact crash.
- Exclusive Safe-n-Sound sliding retractable stabilising bar.
- Toddler mode features four recline positions.
- Improved canopy featuring sun visor for extended shade.
- Rearward and forward facing seat belt Lock-offs provide a more secure fit in the vehicle.
- Reversible padded insert and headrest cover.
- Soft plush fabrics and shoulder pads for superior comfort.
- Handy storage pocket.
- High back car seat Messy Mat with a tuck in rear tab.

AHR™ ✓

TILT & ADJUST

**AHR
Tilt & Adjust
Headrest**



**Hassle Free
Harness**

IN CASE OF ACCIDENT

If your restraint has been involved in a severe crash, you should destroy the restraint even if no damage is obvious. Some insurance companies offer vehicle insurance which covers or partially covers the replacement of your child restraint. Contact your insurance company for further details. Your insurance company may require you to keep the child restraint for assessment, **but do not use the child restraint after a severe crash**. To assist you in making an accident insurance claim cut the following statement and include it with your claim.

NOTICE TO INSURANCE COMPANY CHILD RESTRAINT INVOLVED IN AN ACCIDENT

All Safe-n-Sound child restraints are manufactured to Australian/New Zealand Standards AS/NZS1754-2010 which requires us to advise users of child restraints to "Destroy the entire restraint if it has been in use in a severe crash, even if no damage is obvious". The joint Australian/New Zealand Standards committee CS/85, advise that this statement applies whether a child was in the child restraint or not. We consider a "server crash" as being one where the main body structure of the vehicle is distorted.

There is no method of determining if the restraint has been damaged and we concur with the Australian/New Zealand Standards in recommending destruction of the child restraint.

This notice is to advise you of the requirements of the Australian/New Zealand Standards and our obligation in complying with the standards.

Please assist the owner of this restraint in their claim.

AUSTRALIA

Britax Childcare Pty. Ltd.

A.B.N 55 006 773 600

Head office and registered address

99 Derby Road, Sunshine, Victoria 3020.

PO Box 147 Sunshine, Victoria 3020.

Customer Service 1300 303 330

Email au-custserv@britax.com

www.britax.com.au

NEW ZEALAND

Britax Childcare (NZ) Ltd.

Customer Service 0508 688 822

Email nz-custserv@britax.com

www.britax.co.nz



CRASH EXCHANGE

We would never want you to experience an accident, but unfortunately accidents do happen.

If you experience an accident you may be eligible for a free replacement.

The Safe-n-Sound Crash Exchange Program is a voluntary program designed to ensure that our children are safe and that any seat that may have experienced a severe crash is taken out of the market.

There is no method of determining if the restraint has been damaged in a severe crash, so the restraint should be destroyed as the crash may reduce the child restraints ability to perform.

Since its inception in 2006, the Crash Exchange program has helped 100's of families ensure that their children have new restraints and that the restraints are not sold second hand placing others at risk.

Our Crash Exchange Terms and Application form are accessible on our website. Please visit www.britax.com.au for further information.





AUSTRALIA

Britax Childcare Pty. Ltd.
A.B.N 55 006 773 600

Head office and registered address

99 Derby Road, Sunshine, Victoria 3020.
PO Box 147 Sunshine, Victoria 3020.

Customer Service 1300 303 330

Email au-custserv@britax.com

www.britax.com.au

INTERNATIONAL ENQUIRIES

Contact your local Distributor.

The Safe-n-Sound trademark and other trademarks are the property of Britax Childcare Pty. Ltd. (Australia).

The Britax trademark is the property of Britax Excelsior Limited (UK).

We reserve the right to alter this product without notice.

© 1995-2010 Britax Childcare Pty. Ltd. This product is covered by Australian and overseas Patent applications. Patents pending.